

14 Trends Shaping Tech

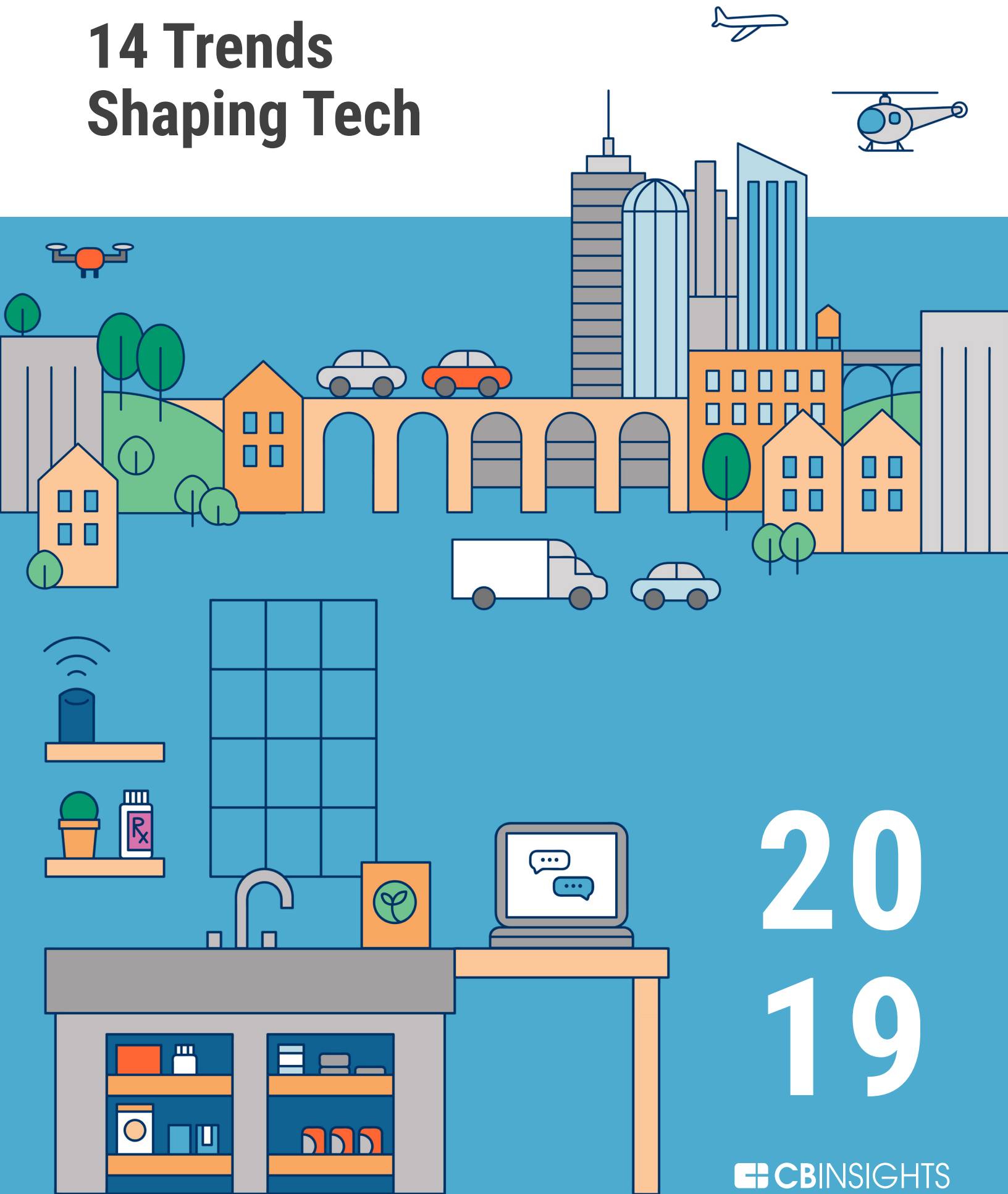

20
19



2019 Trends

The hyper-personalization of everything	4
The smart home targets the senior citizen market	7
Malls are out. Retail moments are in.	11
Maps become a layer for all kinds of real-world data	14
Last-mile delivery gets automated	17
Tech comes for your sleep	20
Data becomes a hot-button geopolitical issue	23
Smart buildings maximize comfort, wellness, and efficiency	26
Buses and logistics providers go green	29
China sets the bar for social network innovation	32
Electric vehicle makers expand into lifestyle products and services	34
Tech apprenticeships grow in popularity	36
Digital swag makes big money	38
The new healthcare clinic is your home	41



The smart home and healthcare are converging. Autonomous vehicles are coming for last-mile delivery. And data is becoming a hot-button geopolitical issue. We look at the trends poised to reshape industries in 2019.



Technology is now central to every industry – from building construction to healthcare administration to food production. 2019 will be the year we see new use cases emerge as AI creates new possibilities for personalization, monitoring, and marketing. It will also create new challenges around how to regulate data and access.

As a more tech-savvy generation ages up, we'll see the smart home begin acting as a kind of in-home health aide, monitoring senior citizens' health and well-being. We'll see logistics players experiment with finally moving beyond a human driver. And we'll see cross-industry collaborations, whether via ancestry-informed Spotify playlists or limited-edition Fortnite game skins. We'll also see technology brands expand beyond their core products and turn themselves into a lifestyle.

We asked our industry analysts at CB Insights to look back over a year's worth of research briefs, data crunching, and reports to identify the trends they believe will shape the tech sector in 2019.

In each case, we examine the tea leaves pointing to each trend as something to watch out for next year. From at-home health kits to personalized makeup to data governance, these are 14 of the tech trends we'll be watching.

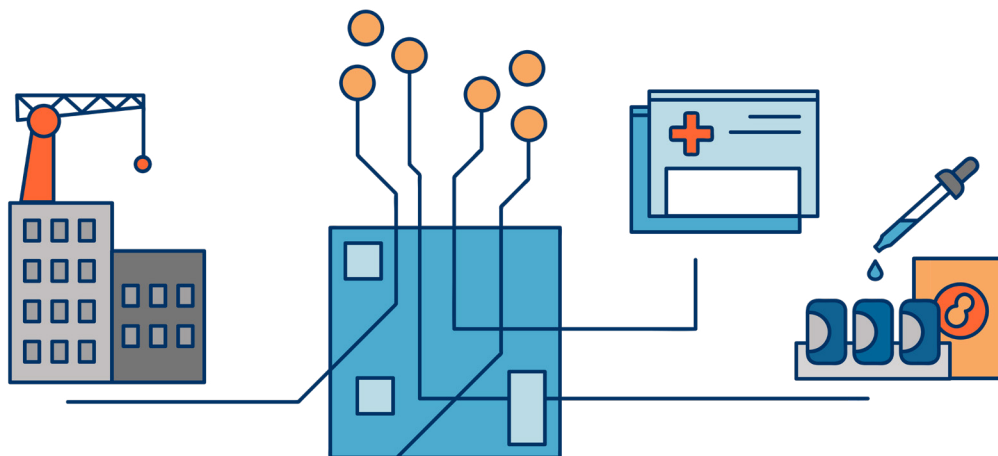



The hyper-personalization of everything



The more data collected about an individual, the more intimately companies believe they can understand and market to them.

In 2019, we'll see an increase in cross-industry collaborations to better understand users and offer them more fine-tuned products.

In September 2018, for example, Spotify partnered with Ancestry.com to utilize DNA data to create unique playlists for individuals. Playlists reflect music linked to different ethnicities and regions. A person with ancestral roots in Bangalore, India, for example, might see Carnatic violinists and Kannada film songs on their playlists.

If you could listen to your DNA, what would it sound like?

LISTEN ON Spotify

With an AncestryDNA test you can discover more about yourself—from learning your ethnicity to connecting with distant relatives. And now your AncestryDNA results can play a unique Spotify mix of music, inspired by your origins.

Get your kit now for \$49
Already a customer? Get your custom DNA Spotify Mix now.

Order now
Includes taxes and shipping

39% Native American/Andean
18% African
17% European

DNA data is also informing how we eat. GenoPalate, for example, collects DNA info through saliva samples and analyzes physiological components like an individual's ability to absorb certain vitamins or how fast they can metabolize nutrients. From there, it matches this information to nutrition analyses that it has conducted on a wide range of food and suggests a personalized diet. It also sells its own meal kits that use this information to map out menus.

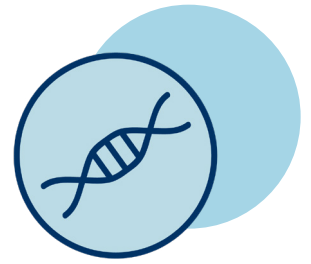

Critics believe that some of these DNA-based personalization tactics rely on pseudoscience. Other more straightforward personalization tactics are emerging via tools like image recognition.

For example, patents indicate that the beauty industry is looking at image recognition to create products catered to individual customers.

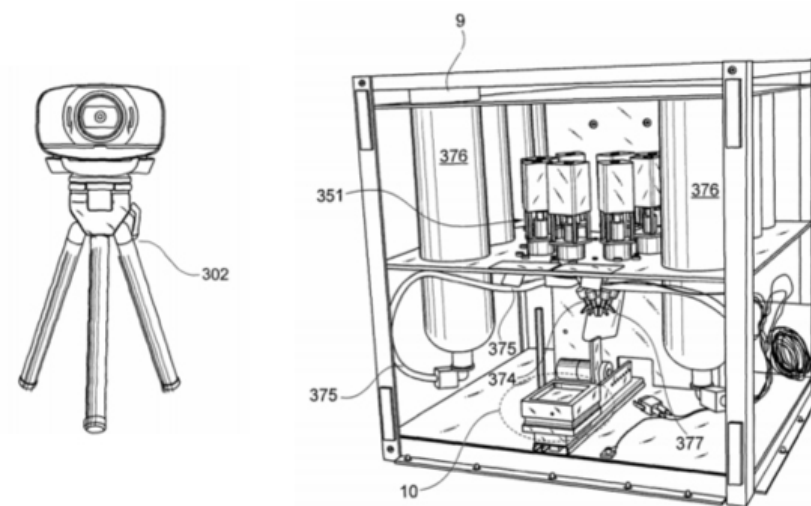

A patent filed in August 2016 by L’Oreal describes using some type of visual mechanism, like a smartphone camera or in-store video device, to gather data on the texture and color of a shopper’s skin and hair. From there, the company would use the information to create a blend that best fits a shopper.

Personalization is inspiring more than just new product features. It’s also helping set preferences for services that are otherwise one-size-fits-all.

Autonomous vehicles, for example, might use personalization data to offer responsive car settings.

In July 2018, Amazon and Apple were both granted patents that would personalize features for autonomous vehicles.

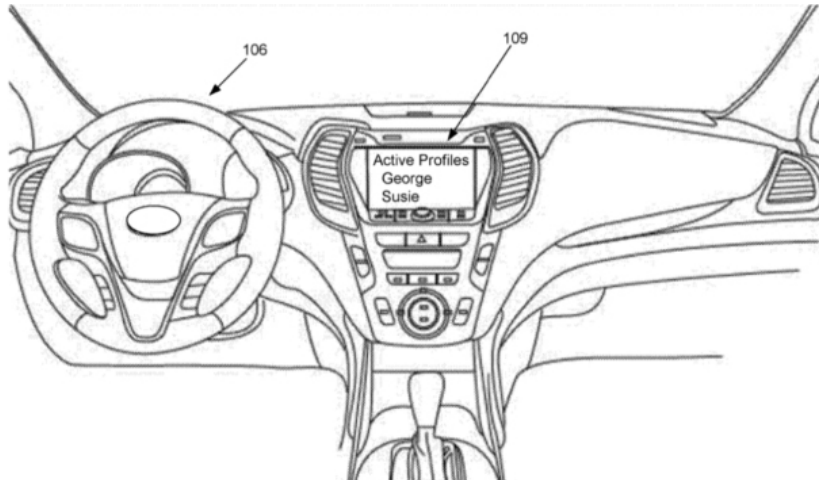

Amazon has patented a system to activate in-car preferences based on the passenger that gets in.

Amazon's patent outlines passenger profiles that build in preferences for how AVs should operate. Preferences include safety, like automatically detecting a child passenger and child locking the doors of a car accordingly. Amazon might even use its technology to limit a car from going to certain locations, like a bar if an underage driver is in the car.

Apple's patent focuses on comfort profiles. Comfort in an autonomous vehicle includes acceleration, braking, and turning. Hypothetically, when a customer enters a car, Apple's facial recognition algorithms will recognize a passenger and monitor things like posture, eye movement, and heartbeats to gauge comfort level.

In 2019, get ready for even more tangential streams of data to broaden the opportunities for personalization.



**The smart home targets
the senior citizen market**



There's a major difference between the senior of 10 years ago and seniors today – older people are much more comfortable with technology.

And as tech-friendly generations age up, new markets open up as well.

But technology that requires user inputs can be a difficult sell, especially to senior citizens. It's a big ask to input blood sugar data into a device or weigh yourself every day. And what if a senior suffers from a heart attack? There's little chance they'll be able to summon a doctor through Alexa while in pain.

For this reason, we'll see smart home-based healthcare technology enter the senior citizen market in 2019 as a passive tool. Patents outline this broad, surveillance-enabled future.

In January 2018, Google patented the use of always-on optical sensors in places like bathrooms to capture data on cardiovascular function. Theoretically, the sensors will track changes in colors in skin to see if blood flow was disrupted. Every time a senior steps into the bathroom to brush their teeth or wash their hands, they will passively provide blood flow data to these sensors.

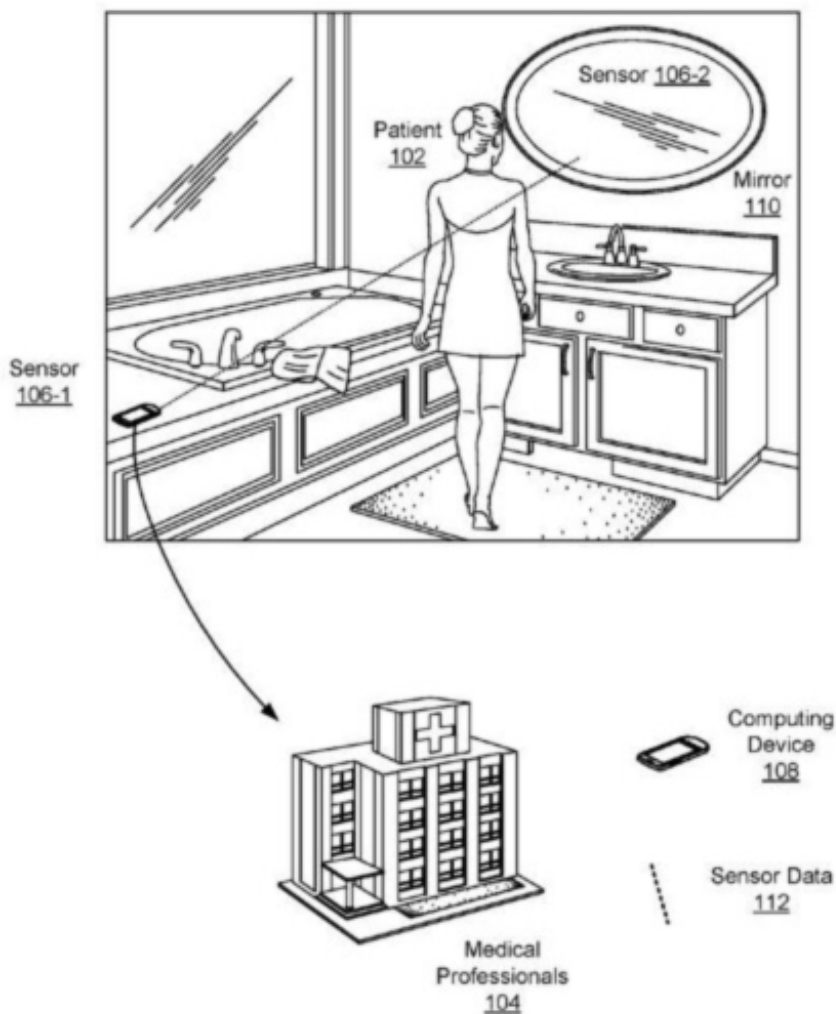

In October 2018, Amazon was granted a patent to detect “abnormal” voice conditions like coughing, sore throats, and even different emotional states like sadness and excitement. If a senior is coughing, Alexa might suggest that they order medicine. If programmed to do so, this coughing data might even go directly to a loved one or a care provider.

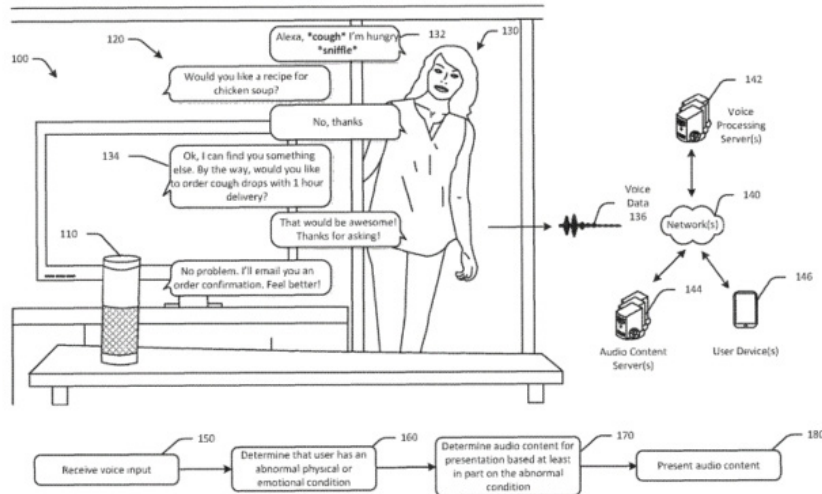

Surveillance technology also helps with passive tracking. The Amazon Echo's drop-in feature allows people to broadcast to any speaker within a home, which means that a user can reach out to a senior without them having to pick up the phone. Indoor cameras like Google Clips use artificial intelligence to keep specific people within its line-of-vision.

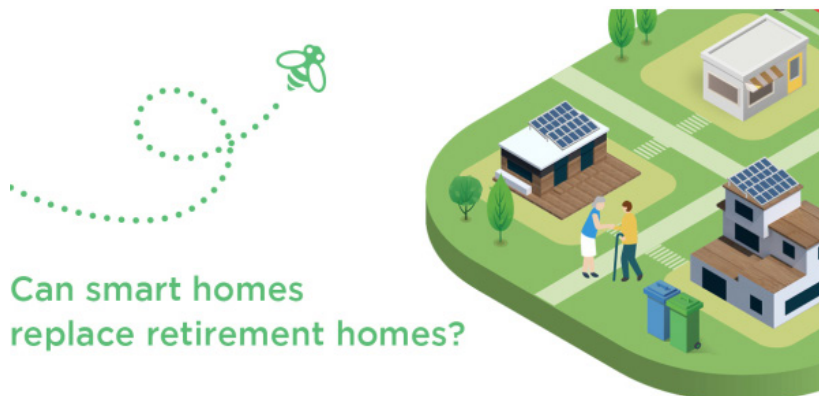

Can smart homes replace retirement homes?

An initiative from Amazon-backed smart thermostat Ecobee urges customers to share their data anonymously to help the company understand behavior better — especially seniors.

Ecobee's sensors might use this data to better understand the movement and changes in behavior of an elderly family member. If a senior has reduced the number of times they go up and down the stairs, for example, they might be experiencing knee pain.

The more passive behavioral data we have on seniors, the more likely these devices will be used to detect major behavioral changes that signal a medical problem.



**Malls are out.
Retail moments are in.**

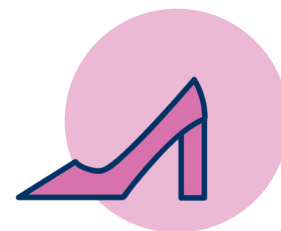

Traditional retail outlets might be struggling, but shopping itself is still as popular as ever, the channels are just changing.

According to Adobe, shoppers spent nearly 24% more this year on Black Friday than in 2017. Cyber Monday hit \$7.9B – up nearly 20% from last year.

But retail isn't just moving online. It's also starting to infiltrate other aspects of our offline world, like car rides.

Startups like Cargo are tapping into the idle moments that riders spend in cabs. Cargo installs boxes with products from big brands inside the cars of ride-hailing companies like Uber. If a customer gets into a Cargo-equipped car, they can scan a QR code or enter a numerical ID to browse the car's inventory and choose a product to purchase. Now, the 30 minutes that might have otherwise been wasted in traffic can be used to buy an iPhone charger or a bag of chips.

Major brands are already signing on to these new retail moments and using them as an opportunity to pilot and sell products. Cargo sources products from big brands, from Kellogg's to Coca-Cola.

Theoretically, these retail moments aren't limited to cab rides. They can be anywhere, enabled by the rise of technologies like augmented reality, cashierless stores, and smart factories. Patents outline what the future might look like.

In August 2018, for example, Walmart was granted a patent that would allow customers to strap on virtual reality headsets and sensor-laden gloves to interact with a Walmart store in a virtual world. Autonomous robots would then fulfill these virtual orders in a Walmart factory.

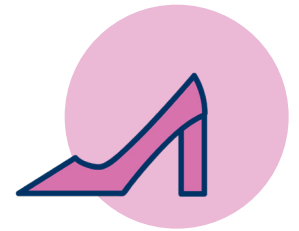

New Walmart patents describe virtual reality shopping

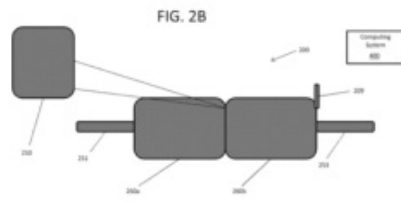

People would put on a pair of virtual reality glasses to shop.

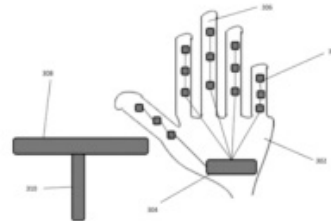

Sensor-laden gloves would detect shoppers' movements and provide sensory feedback.

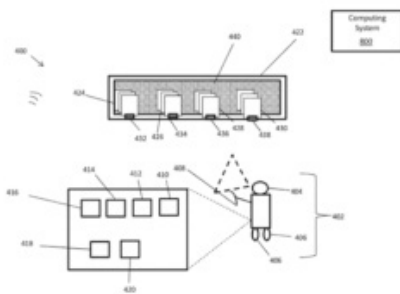

Autonomous robots in remote fulfillment centers would react to shoppers' virtual movements and pick and pack items.

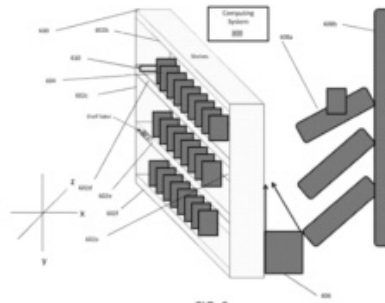

Smart shelves would be equipped with sensors to monitor inventory in real time. These sensors could detect when a product is removed, as well as changes in temperature, moisture, and other attributes.

An older patent filed by Walmart showed that the company might also be envisioning retail pods that can be set up in office spaces, malls, and even in apartment buildings.

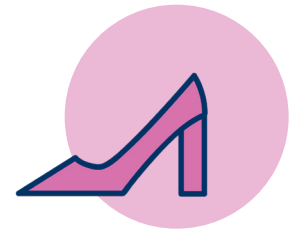

Walmart considers virtual reality-based shopping pods

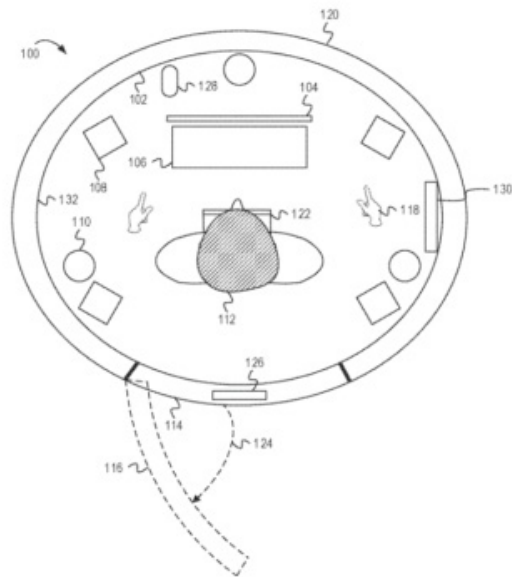

In the future, you might be able to pick up dish detergent on your way home from work at the Walmart pod that sits in your lobby.

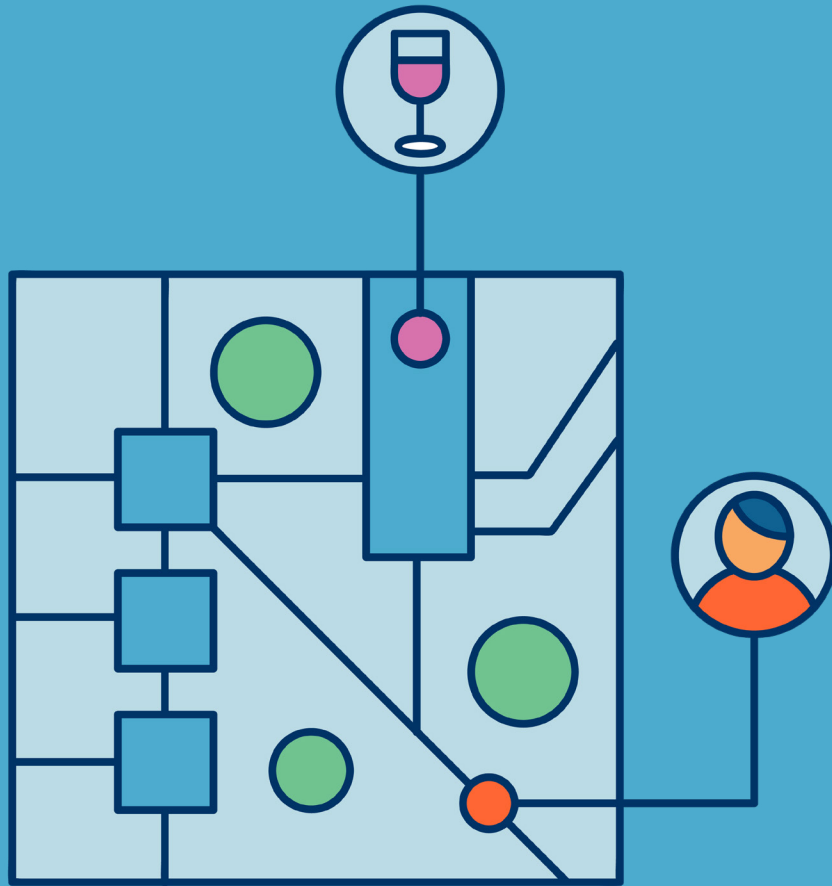

**Maps become a layer for
all kinds of real-world data**

For most, maps are a feature of a smartphone. A user pulls up Google Maps, types in “bars,” and navigates over to the nearest one.

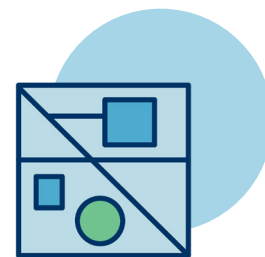

But there’s more potential for maps than just locating nearby happy hour spots – in the future, maps might offer a user bar recommendations based on past preferences, connect them with friends in the area, and even warn them from visiting locations that have high pollen counts.

In 2019, maps will begin to become a layer on which we do everything from communicate to compile data.

We saw an inkling of these possibilities with the smart home in October 2018, when Roomba-maker iRobot partnered with Google Maps. As the Roomba cleans a home, it collects mapping information based on low-resolution photos and how far its wheels move.

The new partnership aims to make the smart home more responsive. Map-based data would make the smart home easier to set up and allow for a more complex chain of commands, like summoning a robot arm to “fetch a beer.” To carry out that command, the robot arm would have to know where the kitchen was, where the refrigerator was, and where a beer might sit.

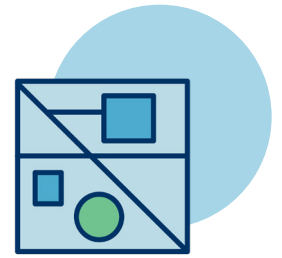

Beyond the smart home, new streams of data are making other kinds of mapping possible. In October 2018, Google rolled out detailed electric vehicle charging station information, including the number of chargers and charging speeds available.

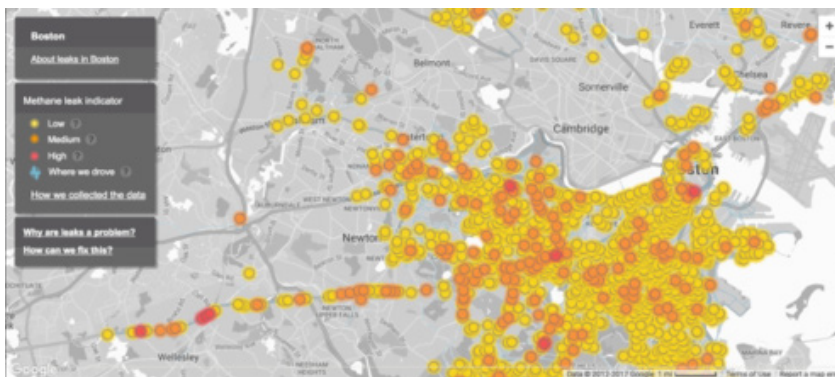

A project last year launched in collaboration with the Environmental Defense Fund and Colorado State University involves adding sensors to Google's Street View cars so they can track methane leaks as they pass through streets.

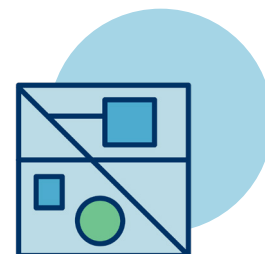

Methane, which contains 80 times the warming power of carbon dioxide over a twenty-year period, can leak from outdated infrastructure meant to transport natural gas into homes. Data from these maps can help utilities decide when infrastructure replacements might be needed.

Google Maps is also starting to add social aspects to its features. In September 2018, Google Maps officially rolled out a polling feature to Maps users. Users can now create a list of places and poll their friends to pick the ones they're interested in.

While Google Maps is the front-runner, Apple Maps is improving its own mapping software as well to better compete.

The company announced plans to build out an entirely new maps interface using its own data. Apple has also mentioned human editors that will go street-by-street to understand the unique and specific geometrics that make up our world.

Its fleet of information-collecting cars have even been spotted with lidar arrays, which help with precise 3D mapping. It also plans to crowdfund this data using "anonymous probes" collected from phones.

These maps will only become smarter and more robust, allowing them to become the latest layer on which we interact.



**Last-mile delivery
gets automated**

The promise of autonomous driving hasn't quite arrived, but last-mile delivery may be the first place where we see fully autonomous fleets deployed.

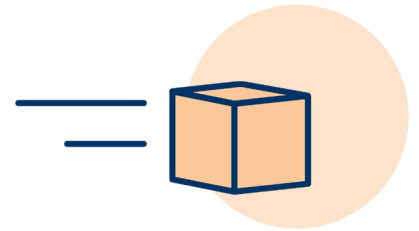

Driving humans across long distances without a driver? Difficult. Driving groceries across short distances without a driver? Much easier. The latter is less of a risk and has immediate use cases. The technology is also easier to develop than full-size passenger-based vehicles – it's smaller, slower, and lighter, and the stakes are lower without human cargo.

Last-mile delivery with a human driver is actually a pretty expensive undertaking. Last-mile costs per delivery can range between 1.50 and 4.00 euros (\$1.75 and \$4.56 in USD), according to McKinsey. More general approximations across the industry place last-mile delivery costs at about 30% of delivering a good. It's a massive industry with a lot of money to be made by solving its inefficiencies. Uber's standalone food delivery app Uber Eats, for example, is the most profitable part of the company.

Major grocery companies and retailers have started piloting autonomous vehicles for last-mile delivery in communities across the US. AVs can reduce fuel costs because they are often electric and need less power to carry cargo than people. They also, of course, save on the cost of paying a human driver.

These pilots are part PR and part strategic initiatives – both for the retailers and the vehicle makers.

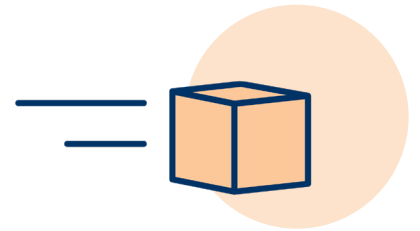

For example, Kroger partnered with self-driving startup Nuro to deliver groceries from its Fry's Food Stores to residents in Scottsdale, Arizona. The pilot launched in August 2018.

Another example involves automaker Ford and Domino's. In July 2018, the duo began a two-month partnership in Ann Arbor, Michigan where customers would order food and have Ford Fusion hybrids deliver it.

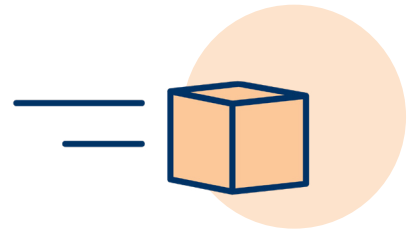

While human drivers were still in control of the car, there was minimal interaction with the customers. Instead, they typed a code in a keypad to retrieve food. However, Ford still pitched the pilot as an autonomous vehicle test – autonomy is a powerful buzzword.

Buzzwords aside, the pilot allowed the company to collect data on what autonomous delivery in the region would look like. Small-scale, low-risk pilots can help companies train their vehicles for future rollouts.

Pilots can also contribute to user research to understand how customers might interact with AVs once they're fully launched.

In 2019, expect more companies to begin using autonomous vehicles in their last-mile deliveries. Some of these use cases might even potentially move beyond pilots depending on regulations, which tend to vary widely by state.



Tech comes for your sleep



Tech has already infiltrated your waking hours. Now, it's coming for your sleep.

From smart mattresses to smart pillows, the products that are being released into the sleep market aim to improve sleep by tracking some of the most enigmatic hours of our days. In 2019, we will see that the trojan horse into this industry is wearable technology.

FitBit announced in August 2018 that it had plans to launch a sleep tracking program known as SleepScore. The technology will use heart-rate tracking sensors on newer FitBits to give users nightly sleep scores and comprehensive views on how they've been sleeping. The sensors can measure oxygen levels in the blood and detect events that might be disrupting breathing during sleep.

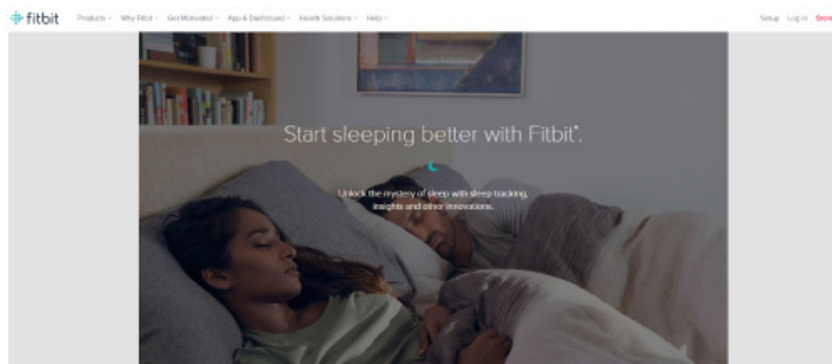



But Fitbit's devices aren't FDA-approved (yet) which means that they can't offer users a diagnosis on what might be ailing them. However, we'll likely soon see more healthcare-based wearables for sleep diagnoses.

In October 2018, Beddr's SleepTuner became one of the few consumer sleep wearables to receive FDA approval. The SleepTuner is a small sensor-equipped patch that a user can place on their forehead while sleeping to track factors that change through the night, like heart rates and sleeping position.

And while the Apple Watch doesn't explicitly track sleep patterns, it has received FDA approval for other health-related technologies. We may soon see the company enter the growing sleep market.





Other companies are moving into your dreams as well. Dreem, which has raised \$58M in funding, sells a headband that customers can wear around their heads while asleep. The band is equipped with sensors that measure key biological signals, like brain activity, heart rate, or movement. It claims that its artificial intelligence tools are precise enough to achieve the same results that a customer might have while testing sleep activity in a laboratory.

The band is also equipped with audio that can coach a customer through meditation and breathing exercises, and emit sound waves that the company claims can help increase the quality of deep sleep. It also attempts to improve waking hours. Its smart alarm only goes off when it detects that a user has moved into light sleep.

While companies have piloted all sorts of technology to try and track sleep data, wearables offer an extra level of precision and granularity that was previously hard to achieve. Expect to see more sleep technology enter the market in 2019 piggybacking on the success of wearables.



**Data becomes a hot-button
geopolitical issue**

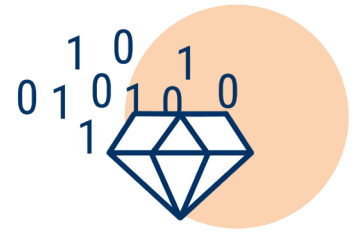

If data really is the new oil, we're starting to see owners of this data protect it like they would a precious resource.

Alphabet's Sidewalk Labs entered Toronto earlier this year with a plan to launch a "smart neighborhood" in Quayside, a pedestrian walkway by the water. But the company's entrance was met with backlash. Toronto residents wanted to know what the company planned to do with the behavioral data that it would collect from this project.



Then, in October 2018, Sidewalk Labs released initial proposals on how digital governance might look in the new Toronto waterfront. They proposed that the information collected from the Quayside environment should be kept in a "Civic Data Trust." Any entity — including Sidewalk Labs — that hoped to collect or use smart city data would have to submit an impact assessment of their data with the data trust. Furthermore, the company promised that all data would be stored on "open standards" — anyone could plug in.

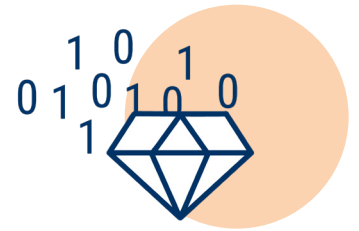

But critics pushed back against it. Because Alphabet's technology allowed it to do much more with that public data than the average organization, the data trust would actually grant equal access to players that were unequal in their technological prowess.

Solutions to this issue have ranged from selling this data for a price or partially walling it and only allowing access to some.

This kind of clash between citizens, governments, and tech companies over how to protect, access, and manipulate user data is likely to intensify in the coming year. Across the world, we're seeing a data localization trend start to take hold.

India's Prime Minister Narendra Modi mandated in October 2018 that all non-Indian fintech companies operating within the country, like Mastercard and Visa, had to keep payment data on domestic transactions within the country.



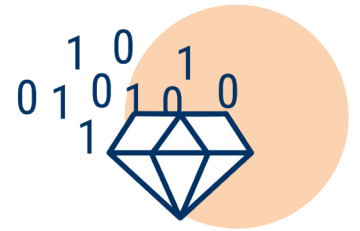

The country is also working on a law that will localize all data produced in the country, including e-commerce and cloud data. These moves aren't pure protectionism. They also provide Indian companies with a fighting chance to win over the country's customers that are being aggressively pursued by tech companies from United States and China. While lobby groups that represent big tech, including FAMGA, are fighting against these laws, the Indian government has shown little sign that it will change its mind.

In neighboring China, data localization is already the norm, with stringent regulations around companies across industries, from telecommunications to fintech.

With tech company data breaches and misuse in the spotlight, and more people recognizing the power that comes with owning mass user data, expect to see more push back around who gets to hold and own data in 2019.

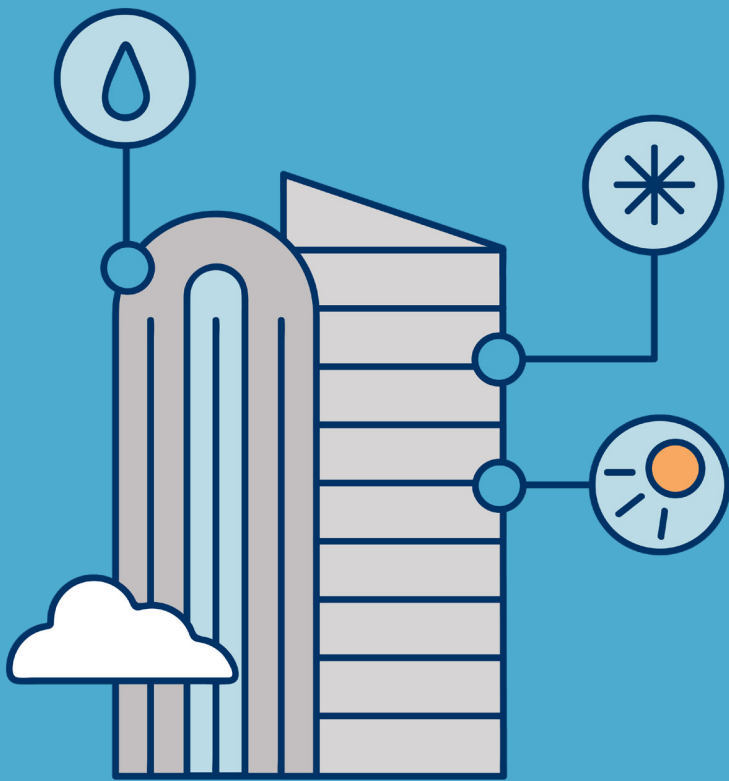

**Smart buildings maximize
comfort, wellness, and efficiency**



Whether it's home offices or coworking spaces, we're seeing a new emphasis on comfortable, intuitive office spaces.

We want our offices to be places where we can do our most productive work, from ergonomic chairs to the right type of lighting.

The problem is comfort is hard to define. No two people necessarily agree on what comfort looks or feels like. (Think co-workers disagreeing over the best temperature to set the thermostat.) In 2019, expect to see the word "comfort" used as a metric more often, and to see increased effort to bring greater comfort to buildings and workplaces.

Rooms are warmer when there are more people in them, but are often cooled with the same settings regardless of occupancy. New sensors will track the number of people present at any given time and adjust aspects like heating, cooling, and lighting to match. In 2018, Amazon-backed Ecobee released an occupancy sensor to track the number of people that are in a room and adjust HVAC systems accordingly.

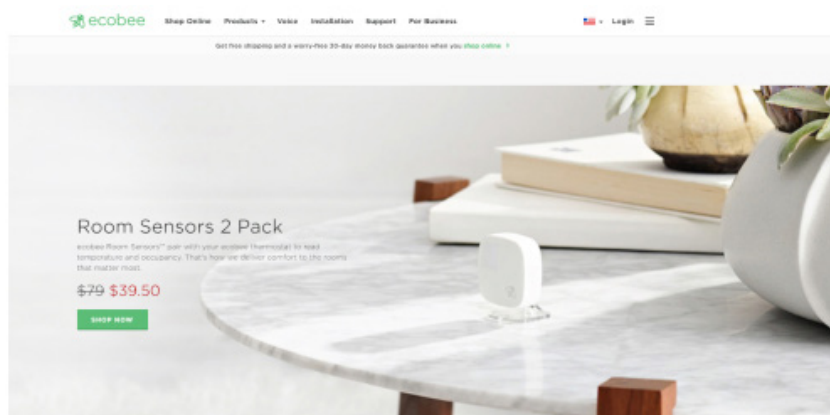



Enviro, on the other hand, uses sensors that take in data on factors like heat, carbon dioxide, and moisture to determine the number of people in a room. From there, HVAC systems are adjusted to match occupancy.

Occupancy metrics are also useful for energy efficiency. Buildings are not left wasting energy once people have left.

Buildings will also begin to emphasize personalization. While sensors in different zones can gather data on larger areas, it's much more difficult to get a data-driven understanding of what's happening at each employee's desk. And different weights, clothing styles, and preferences change how each person experiences their workplace.

GreenMe's Cubes are small enough to be placed on individual desks, and they measure parameters from lighting and temperature to air quality, noise level, and light flickering. In aggregate, this data feeds into a building monitoring and control system. From there, operators can come to a consensus on heating and cooling norms.

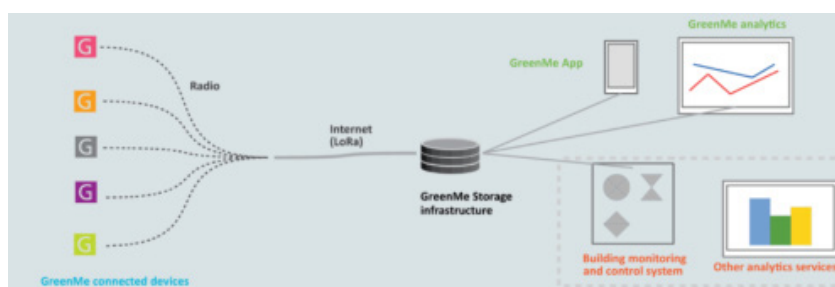

In addition, by providing employees with controls over HVAC systems, office workers can monitor how cold or warm they like their workplaces.



Comfy, which was acquired by Siemens in June 2018, has created limited, occupant-facing controls that can be used with existing HVAC systems. The company installs sensors and IoT devices in buildings so that occupants can adjust temperature and lighting.

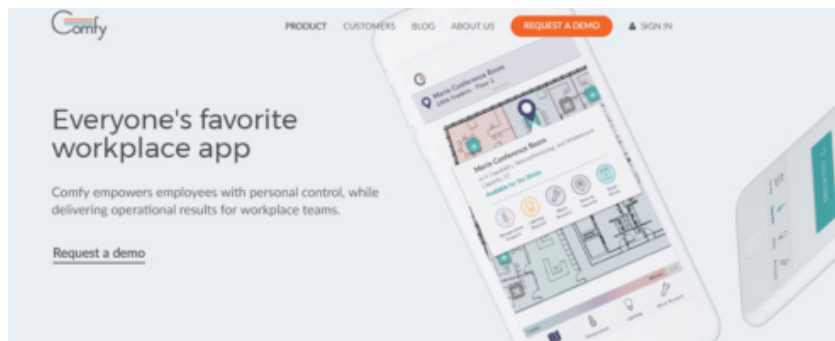

Many companies also crowdsource information on controls.

BuildingIQ's app comes with a "Comfort" module, which allows tenants to notify the facilities team if an area is too hot or too cold. The module creates a heat map from this information and compares it with the building's heating and cooling system settings.

Similarly, CrowdComfort allows occupants to send locations and images of issues detected in their workplace. They can also send in temperature control requests. CrowdControl describes this community as a "human sensor network."

Why now for smart(er) buildings? Wellness, mental health, and productivity are all top-of-mind. And fancy tech offices and coworking spaces have made the workplace environment a new battleground for recruitment.

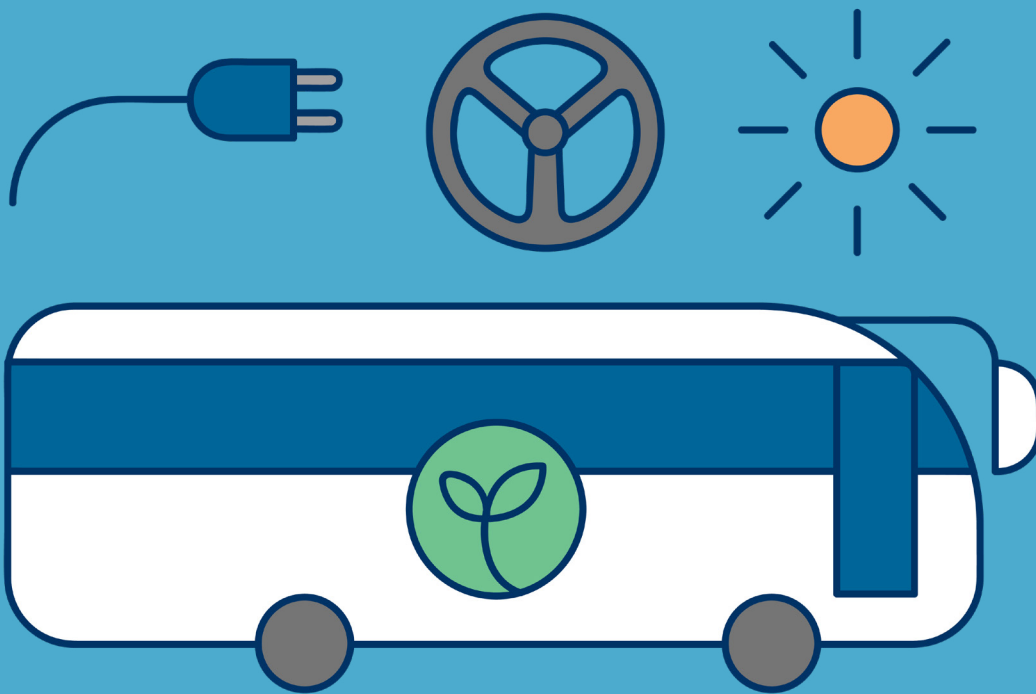

Buses and logistics providers go green

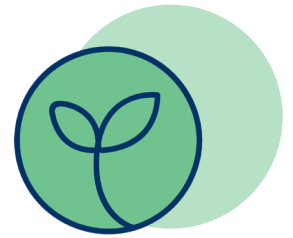

Convincing individual consumers to change out their conventional gas-powered cars for electric vehicles is a steep ask. It's expensive, and owning an electric vehicle can still be inconvenient.

This is likely why we're seeing electrification come first for larger fleets of vehicles, often operated by governments and companies. Buses and trucks emit more toxic materials than the average vehicle. And with larger budgets, the move to electric vehicles — and the long-term financial payoff — can be an easier sell.

Buses, especially for school and public transit, will see increased electrification next year. Bus electrification circumvents some of the problems that an individual electric vehicle owner might face: routes are static and predictable, and infrastructure is easy to build out and plan for. And, just like electric vehicles, studies have shown that the elevated upfront costs eventually pay for themselves over time.

Many school buses have operated on the same engines for the past several decades, with the Diesel Technology Group estimating that roughly 95% of school buses in the US still burn diesel fuel. Perhaps most importantly, school buses carry precious cargo who may be adversely affected by emissions — children.

In September 2018, electric bus maker Proterra raised a round of funding with participation from Daimler. Together, the two announced plans to work on electrifying Daimler's line of school buses. While the duo haven't announced any initial buyers, they have guaranteed that electric school buses will soon enter the market.

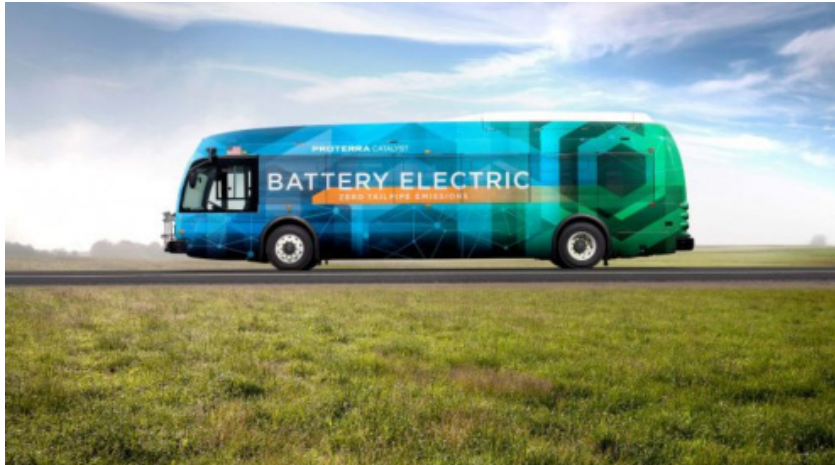
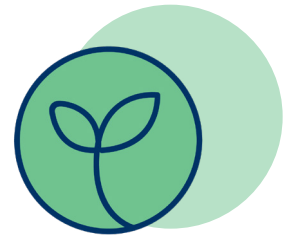

Estimates place school bus counts across the United States at 480,000, making it the country's largest form of mass transit. In White Plains, New York, electric buses got on the road in fall 2018. Each bus cost around \$380K, much more than the \$100K expense of traditional buses.

But there are ways that these buses might be able to balance costs over the long-term. White Plains bus operator National Express partnered with New York utility Con Edison to figure out how to use these buses to help power the grid during the summer. This is a use case that is particular to school buses: with long stretches of idle time, including peak hours in the evening and all summer, they have the capacity to help balance the grid.

Public transportation buses are also getting electrified. In January 2018, New York's MTA began a pilot with Proterra and New Flyer to roll out ten electric buses across its fleet. The pilot also included plans to build out infrastructure for buses to charge in the future, including charging stations at warehouses.

Another broader vehicle demographic that will begin electrification in 2019 is trucks. Earlier this year, Volvo partnered with Greenlots, which builds electric vehicle charging infrastructure and management software, to build out infrastructure in warehouses in Southern California.

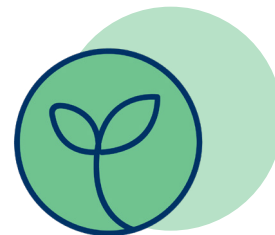

Across the trucking industry as well, greener vehicles are gaining traction. In May 2018, beer-maker Anheuser-Busch placed an order for 800 fuel cell-powered trucks from Nikola Motor Company. These trucks use hydrogen fuel to refuel, and can drive longer distances than electric vehicles.

Coupled with the urgency of decreasing emissions and the long-term lowered costs that come with electrification, expect to see other large fleets of vehicles go green in 2019.



China sets the bar for social network innovation

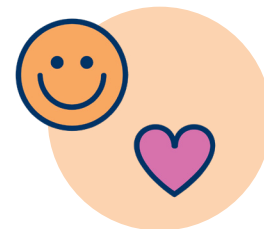

As of October 2018, the world's most valuable private tech company is China's ByteDance, valued at \$75B.

The company operates a video mashup app TikTok, which allows users to record videos, overlay them with music and filters, and share them with friends.

\$75B for a video app may seem like a lot, but the company is popular across the globe. After it acquired Shanghai-based rival Musical.ly in November 2017, it rebranded the company under its name. Musical.ly was popular in the West, while TikTok was popular in the East — together, they had millions of users. In July 2018, ByteDance estimated that 500M users across the world were active users of its app every month.

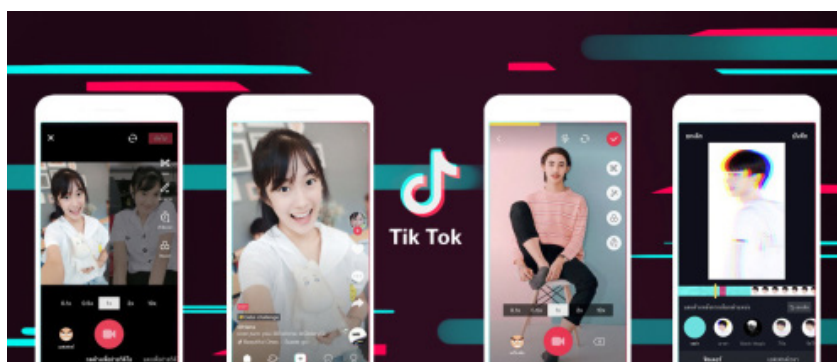

To keep up, Facebook launched a similar app known as Lasso in November 2018. Just like Musical.ly, Lasso users can film short videos, edit them with soundtracks and filters, and share the results with friends.

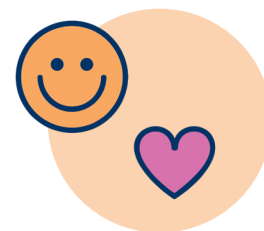

This isn't the first time we've seen a major American tech company copy popular features piloted by Chinese companies.

The face filters that are so ubiquitous now, on Snapchat and Instagram. The idea first came from popular Chinese photo booths from the early 2000s – in 2008, face filter app Meitu became operational.



In October 2018, Facebook-owned WhatsApp enabled the use of stickers. Stickers are already a big part of popular messaging apps from Asia, like Line and WeChat. Many of these companies even charge for more premium stickers – according to Japan's Line's filings when it went public two years ago, it made about \$270M on stickers.

In the future, we expect to see more China-based social networking activity influence Western tech, especially as companies from China start to cross borders and gain market share with non-Chinese users.



Electric vehicle makers expand into lifestyle products and services

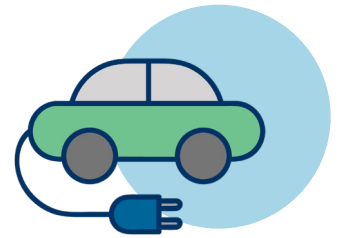

Buying an electric vehicle is an environmental choice for some and a luxury purchase for others.

But electric vehicles also require a lot of time from their owners who must wait for their batteries to charge for anywhere from 30 minutes to two hours.

That's a lot of idle time – and is sometimes the reason cited by conventional car owners for not buying an EV. Now electric vehicle companies are trying to turn this idle time into an asset.

China's NioHouse couples charging stations with a host of activities. At the NioHouse, a user can visit the library, drop children off at daycare, cowork, and even visit a nap pod to rest while charging.



Nio has also partnered with fashion designer Hussein Chalayan to launch and sell a fashion line, Nio Extreme. The pieces in the line are inspired by Nio's EP9, which it claims is the world's fastest electric vehicle.

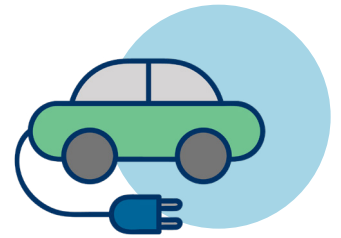

Elon Musk has also teased the idea of rolling out similar lifestyle options at Tesla charging stations.



Right now, Supercharger stations have small convenience stores and lounges. But the Tesla charger of the future might include a restaurant with a drive-in movie theater and waiters on roller skates, according to Musk.

As electric vehicles inevitably overlap with the luxury vehicle market, many customers may be ready to buy into alternative lifestyles. And for electric vehicles to compete against traditional combustion engine vehicles, they need to sell everything – the luxury, the environmentalism, and the lifestyle.

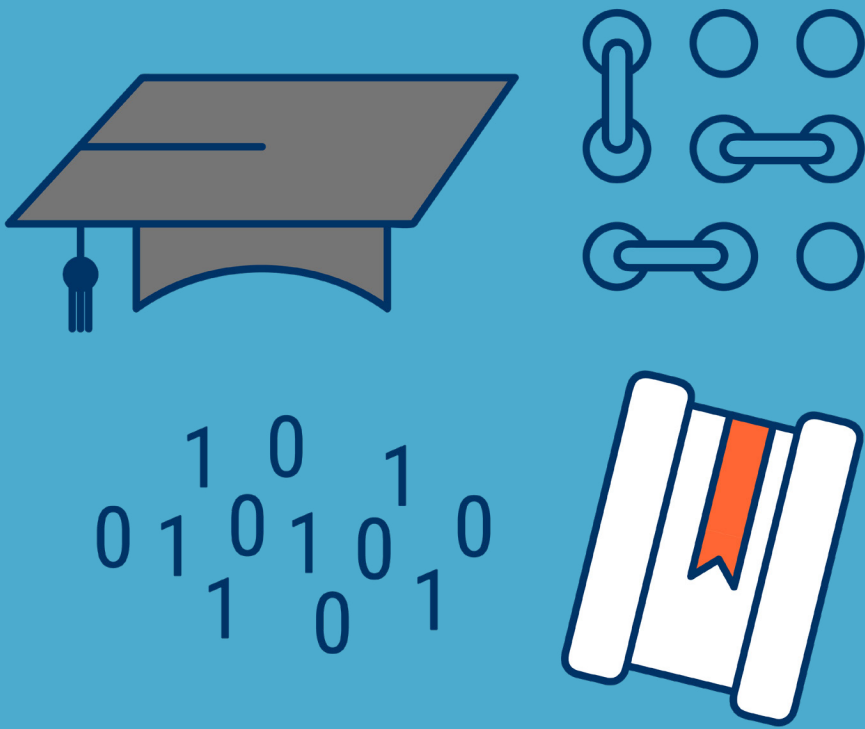

Tech apprenticeships grow in popularity

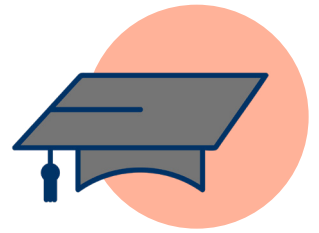

The tech industry moves fast. It's not always easy to gain skills in college that employers are still looking for after graduation.

Meanwhile, students rack up thousands of dollars in debt.

Tech companies are attempting to bridge the gap between academia and the career market.

Companies like the Lambda School and Flatiron School offer courses to train students on exactly the skills they will need to get a job. These apprenticeships mostly focus on tech skills like computer science and coding. Training comes with the explicit goal of employment and students only need to pay their tuition once they've landed a job that pays them above a certain range.

An Education That Banks On You

We believe that education should invest in you, not the other way around. As a Lambda student, you pay nothing until you're earning \$50k or more. And if you don't, it's free.

[WATCH JORAM'S STORY ▶](#)

"I never thought I was the type that could land a high-paying tech job, but I just accepted a high-paying job as a software engineer. And I haven't paid Lambda School anything so far!"
— Joram Cleveus, Full Stack Web Track

These schools aren't just reaching out to students. They've also partnered with tech companies who recruit from these more vocational-focused training programs. Lambda School partners with major technology companies to build out curriculums and set up post-graduation introductions.

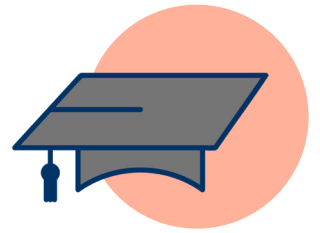

Big tech companies are also starting to offer their own internal apprenticeship programs. IBM, for example, takes in apprentices and trains them on the specific skills needed for roles that involve cybersecurity, data analytics, and product management within the company. Apprentices are all ages and come from a diverse range of backgrounds.

So does this signal the end of college? Probably not. But for the tech savvy, apprenticeships are an emerging, more affordable option.



**Digital swag
makes big money**



In July 2018, Epic Games' free-to-download game Fortnite hit over \$1B in sales.

The entirety of that money came from in-game purchases, like skins.



Skins change how your player looks, not how they play, and can be bought with V-bucks for the equivalent of \$8 to \$20.

They're so popular, they're even bringing in partnerships.

Early in November 2018, NFL partnered with Epic Games to add NFL skins to the game. They were taken off within a week, with many speculating that the addition might have sparked controversy at a time when the NFL is under scrutiny. However, the partnership's short time frame might also be a part of the business model: the skins become limited edition and more valuable when they're scarce.

The craze around digital goods and collectibles is a trend that will continue into 2019. While these goods can't be owned in the physical world, they come with clout, and offer personalization and in-game experiences to otherwise one-size-fits-all characters. They're also just fun.

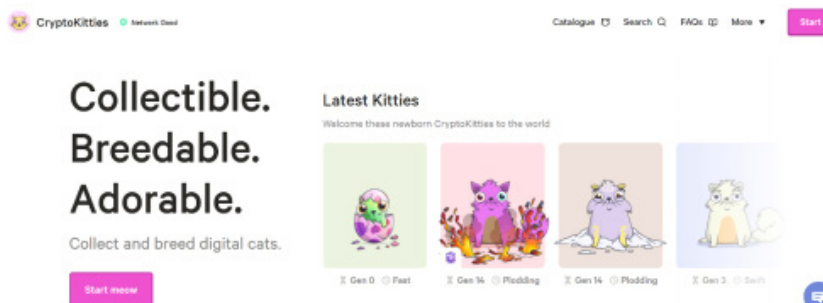

Investors are betting on the rise of these goods. CryptoKitties, which is an Ethereum-based game that lets people buy, breed, and collect different types of rare digital cats, has raised \$27M in funding from a star-studded list of backers, including Google Ventures, Andreessen Horowitz, and Union Square Ventures.

CryptoKitties is using the notion of scarcity to its benefit. Limited edition first-generation cryptokitties go for high rates. In May 2018, a buyer purchased a cryptokitty, pictured below, for \$140,000 worth of ether. CryptoKitties continues to make its kitties scarce. In February 2018, it capped the number of Fancy Cats, a type of digital kitten, thereby making them “limited edition.”

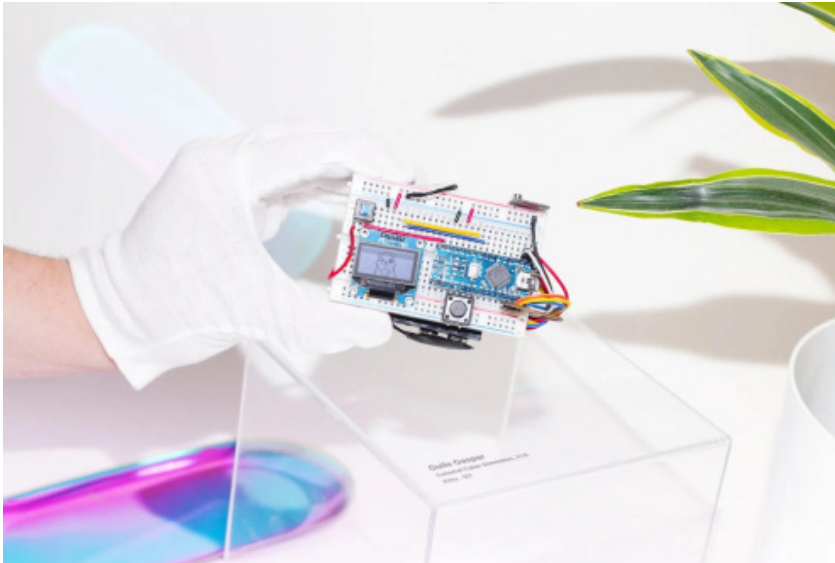

For individuals, digital collectibles open the door for personalized, immersive experiences. And for companies, digital collectibles are one way to offer a diverse range of experiences within their ecosystem.

Most importantly, users are willing to shell out for digital swag.



**The new healthcare
clinic is your home**



The lack of affordable, widely available medical care is a well-documented problem.

In rural areas, hospitals and clinics are often many miles away. There aren't always certified professionals available and patients often put off trips to the clinic if the issue doesn't feel urgent. While telemedicine can solve some of these problems, tech startups in 2019 will start to focus more on another distribution method: at-home kits.

Companies are launching home kits for everything from sequencing the microbiome to DNA testing to check for health risks. Most importantly, these companies are adapting best practices from other D2C (direct-to-consumer) companies, like enabling automatic refills and allowing for personalization.

The need is particularly urgent for stigmatized health services, like women's reproductive health, which is regulated and limited in different parts of the world. Nurx, for example, sells birth control pills in states like Texas, where some areas have limited access to women's reproductive health services. It connects customers with local physicians who are equipped with the credentials needed to write prescriptions. The company can also automatically refill and renew these prescriptions.

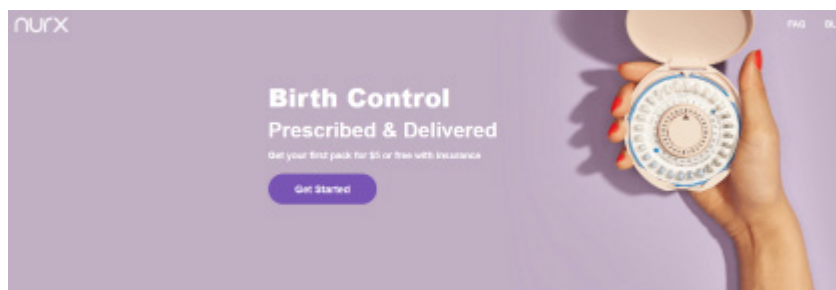



Another perk of having in-home kits is that more data can be gathered when kits are used regularly at home. Quanovate's Miracare, which helps women track their fertility cycles, sends customers a urine tracking device and analyzer. It collects information on changing fertility hormone levels and sends this information to an app.

This data can then help personalize fertility predictions to match an individual's cycle.

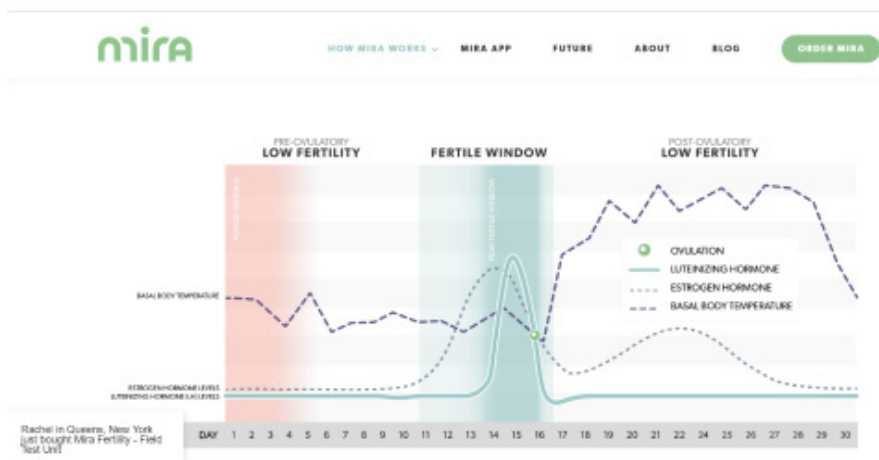

These kits can help make services that may otherwise be expensive and hard-to-access more affordable.

WHERE IS ALL THIS DATA FROM?

**The CB Insights platform
has the underlying data
included in this report**

[CLICK HERE TO SIGN UP FOR FREE](#)