

兩個耳朵

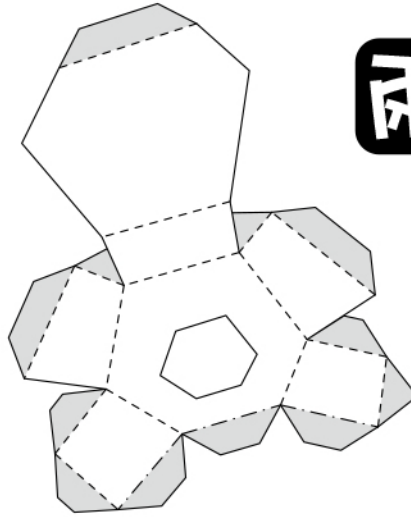

Left ear

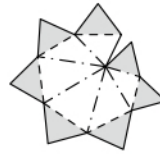

Right ear

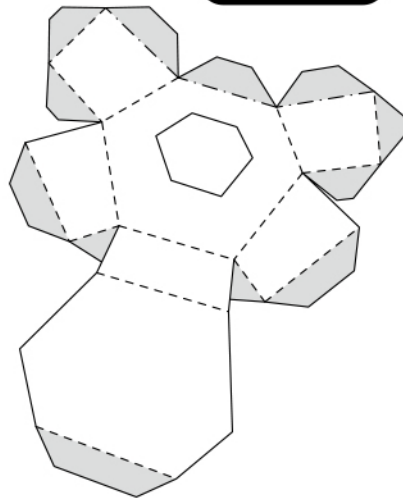
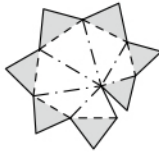

下顎脖子跟喉結

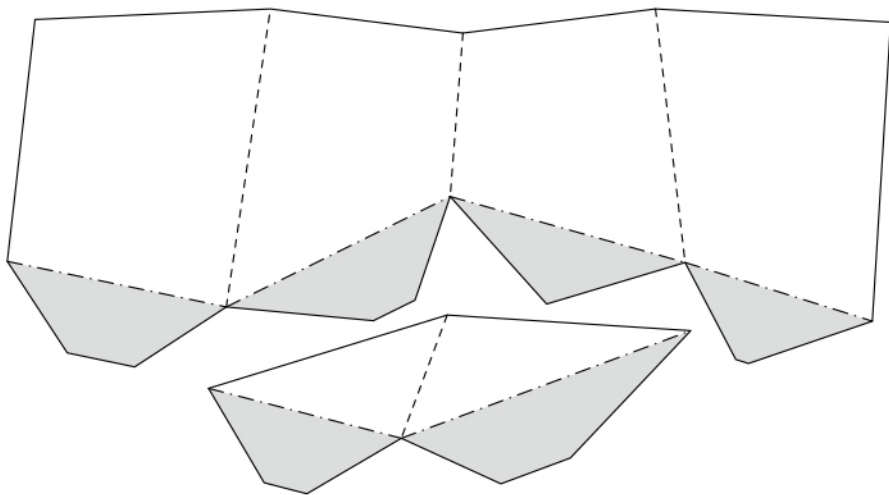
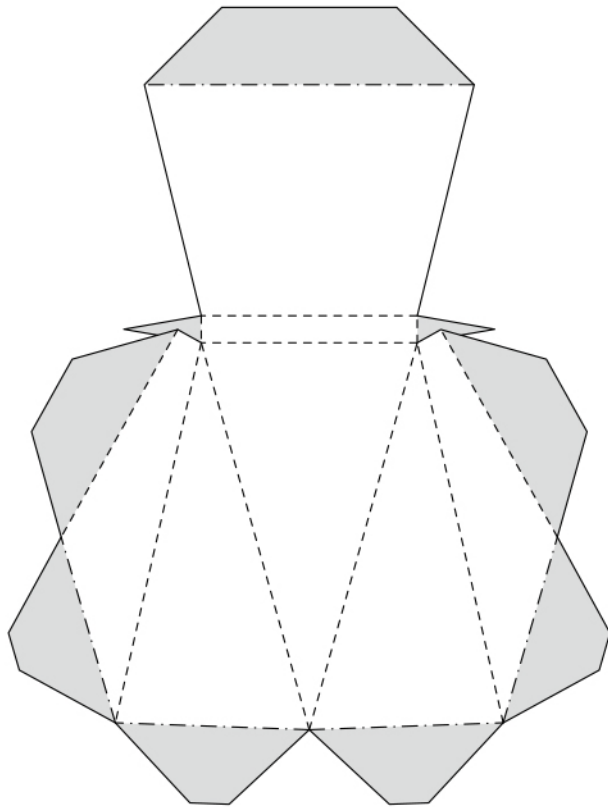

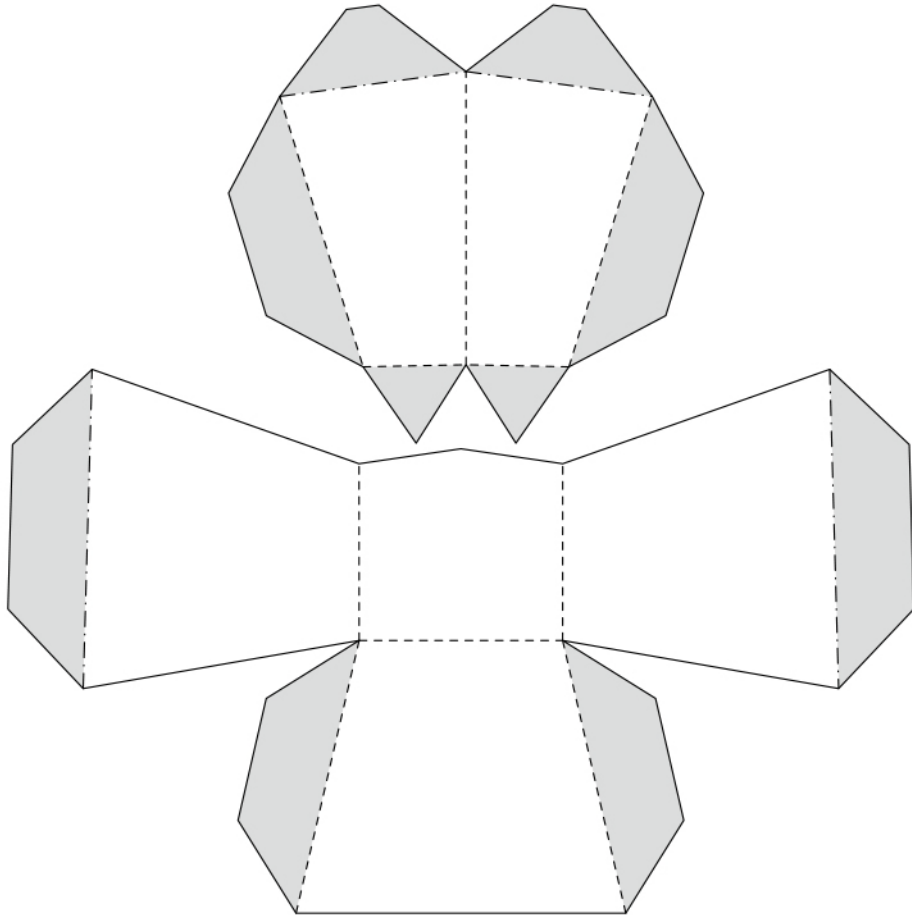

上顎

頭

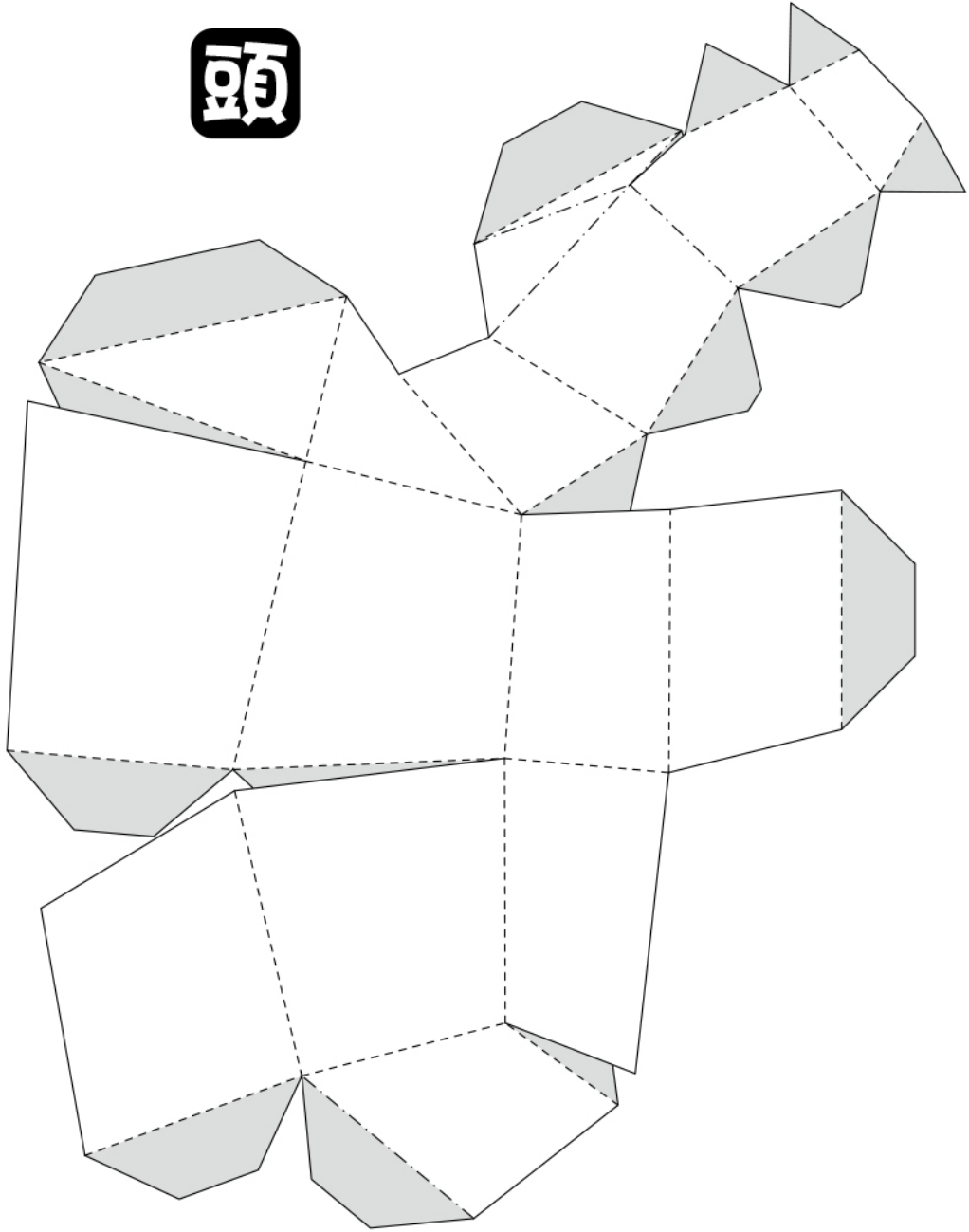

頭

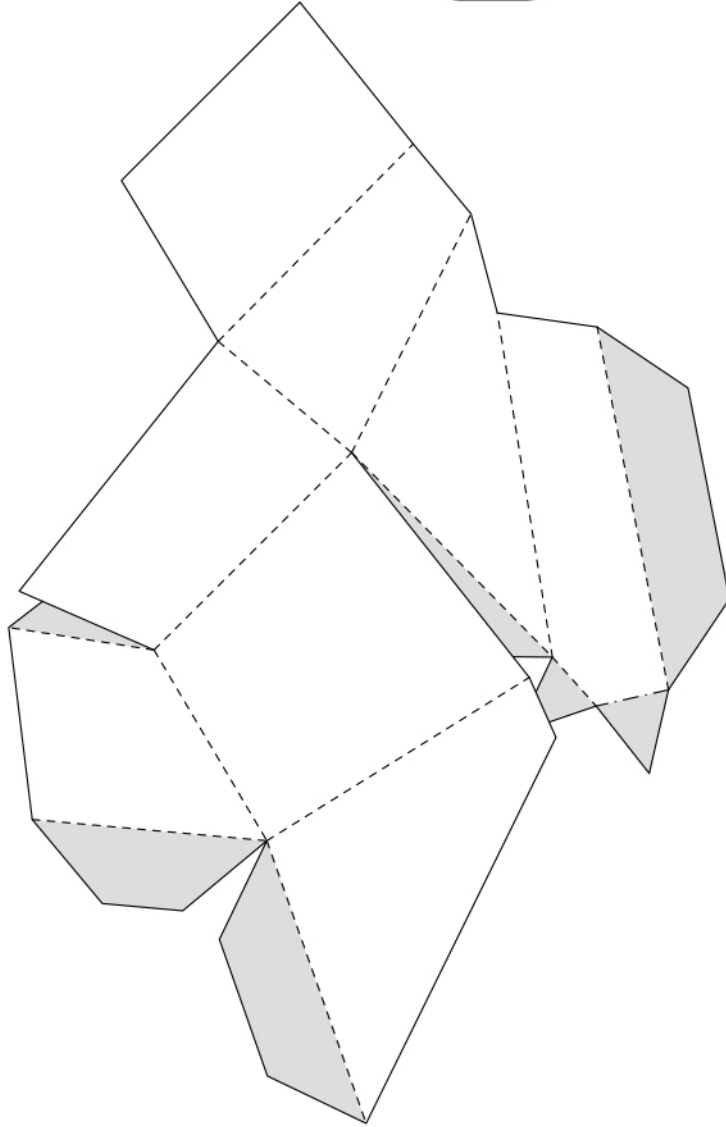

頭底板

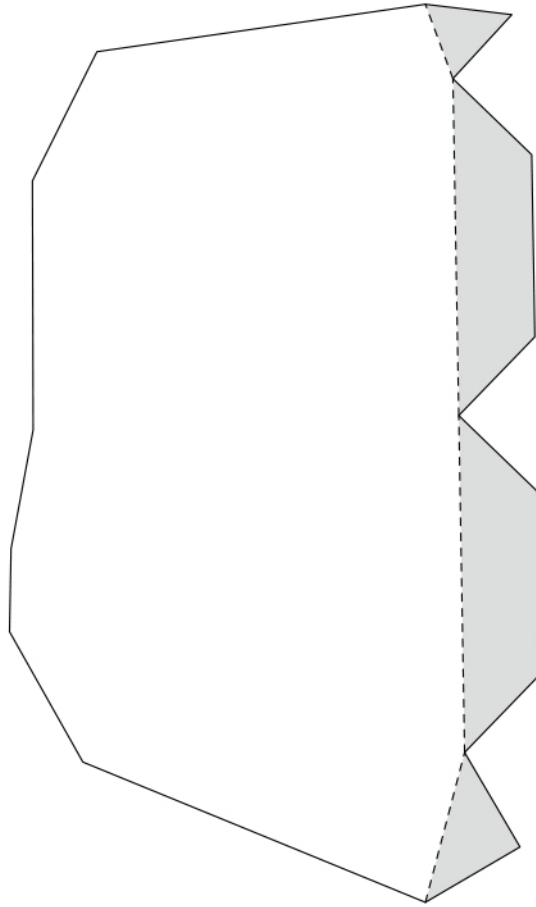

右手掌

Right hand

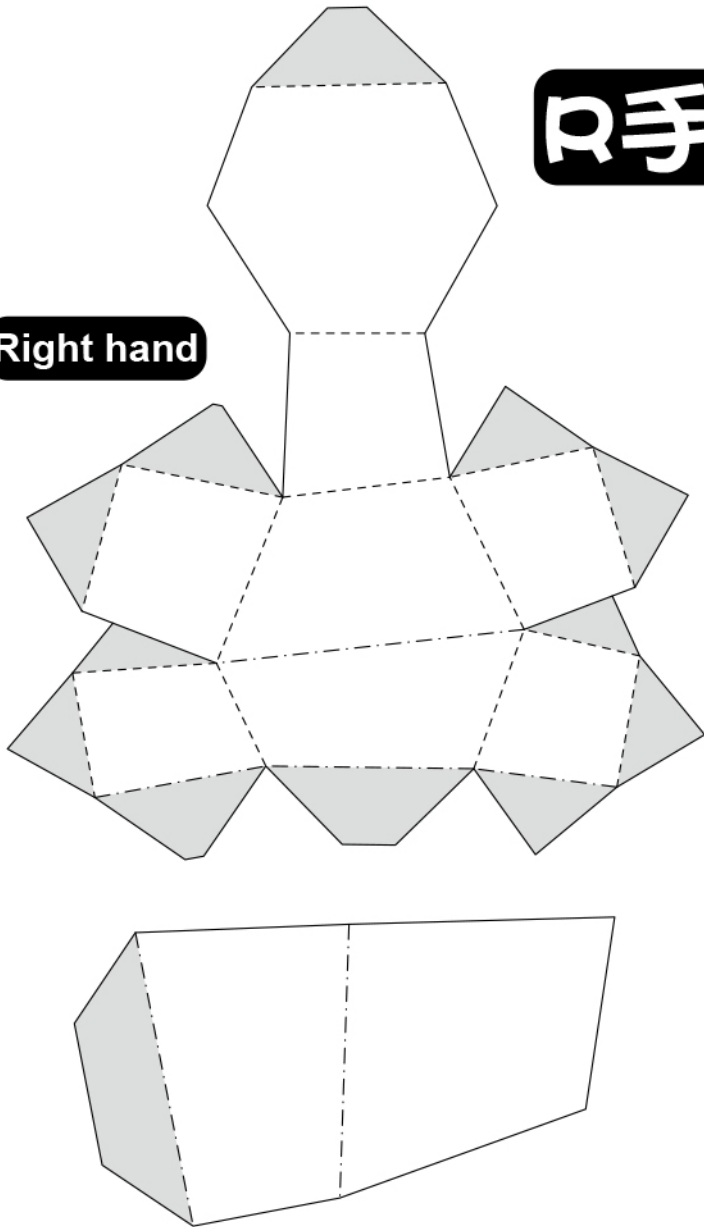

し手掌

Left hand

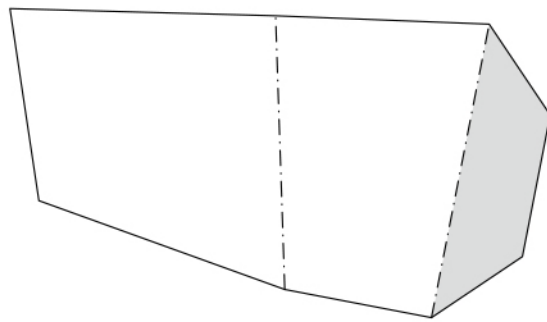
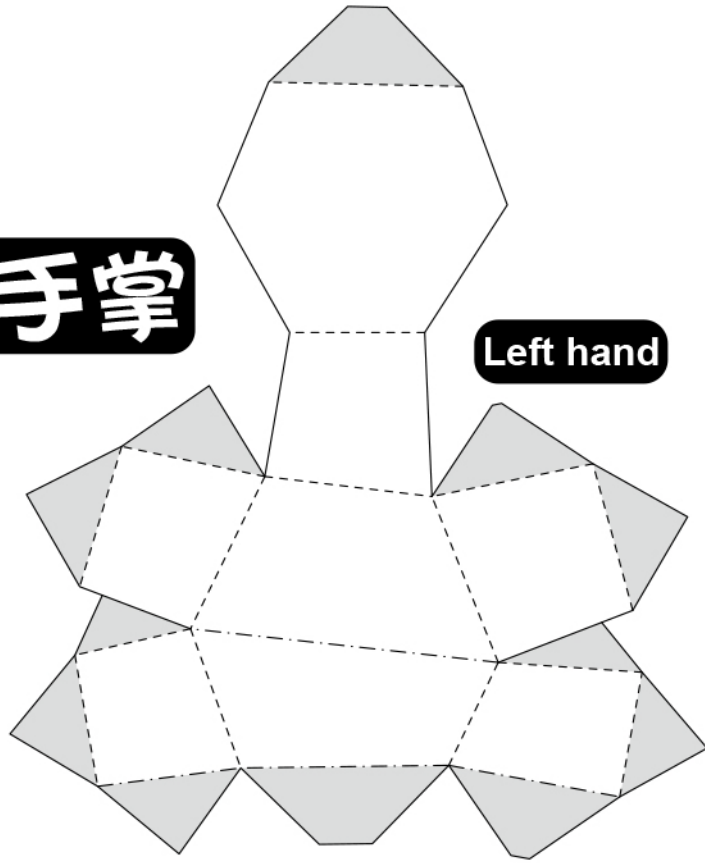

Right arm

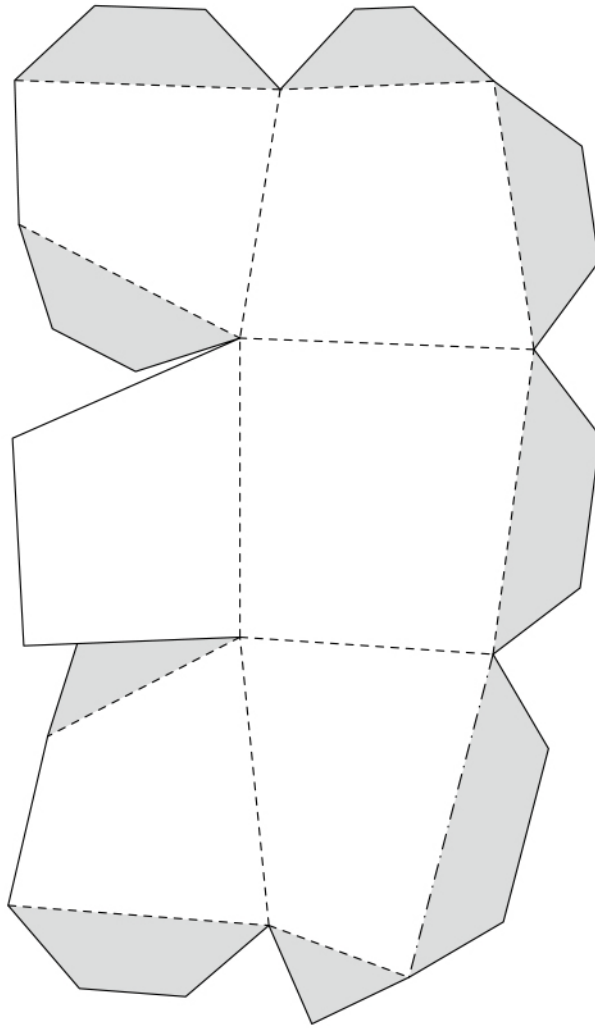

右手前臂

Left arm

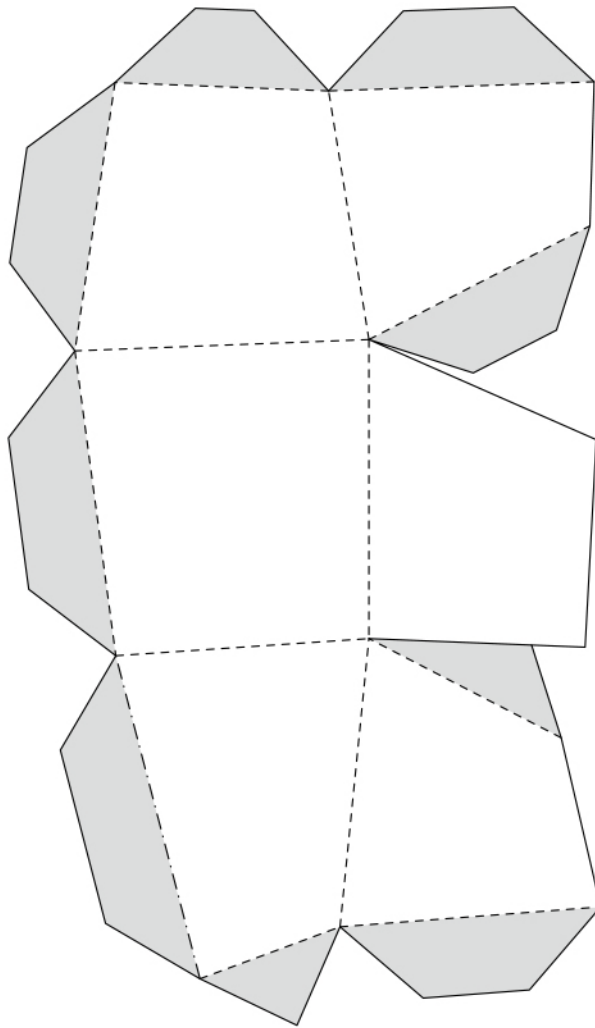

左手前臂

R手上臂

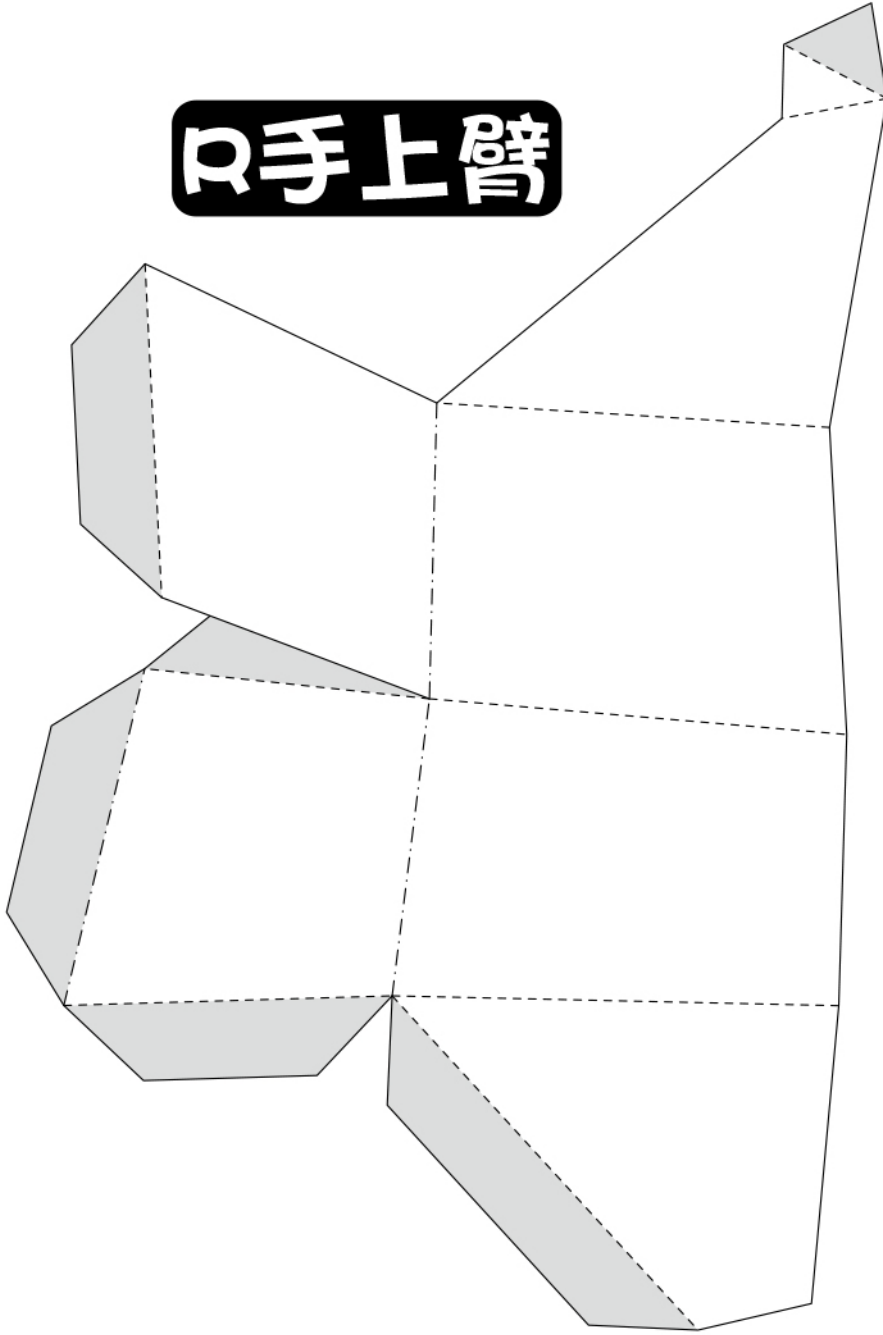

し手上臂

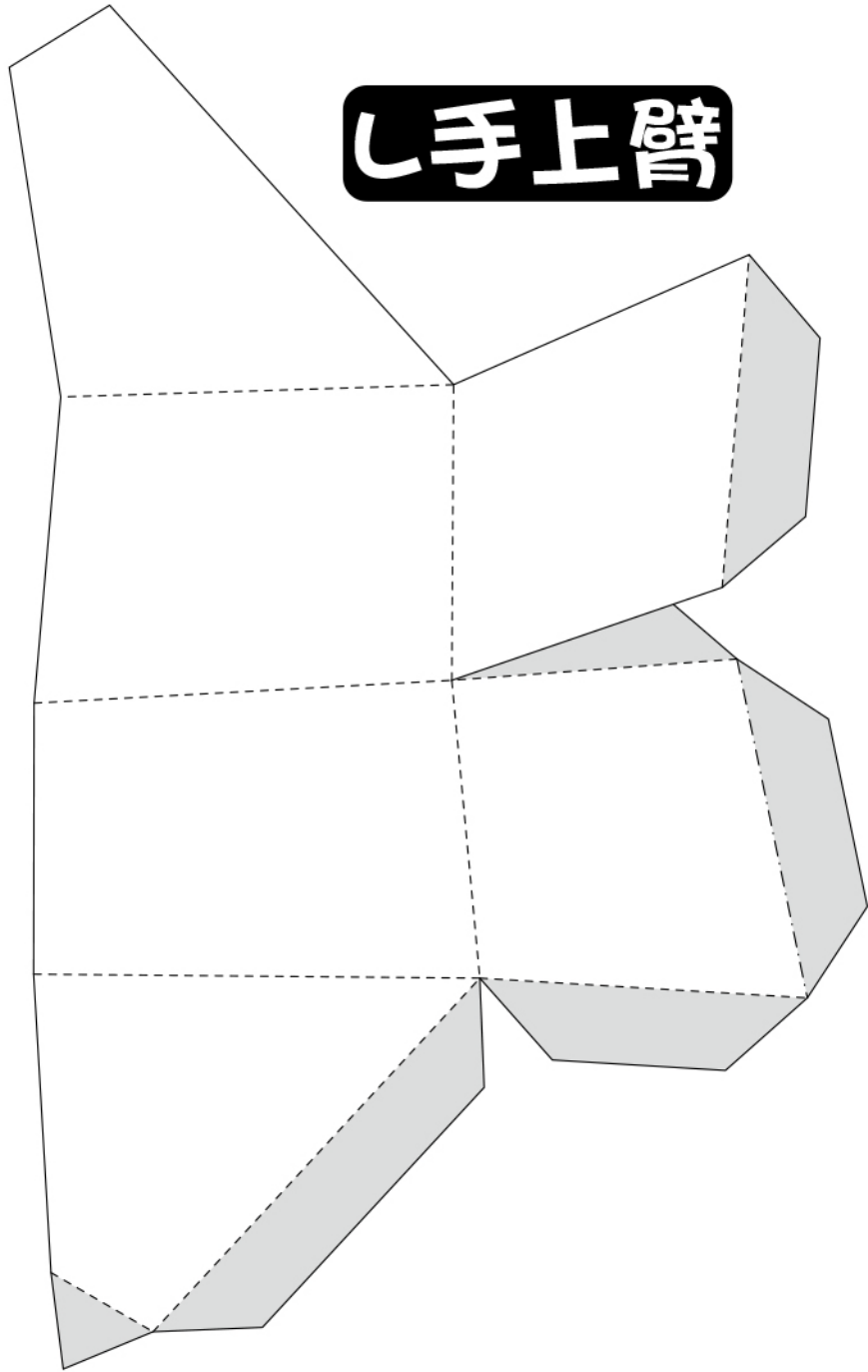

白色舌頭胸毛口鼻

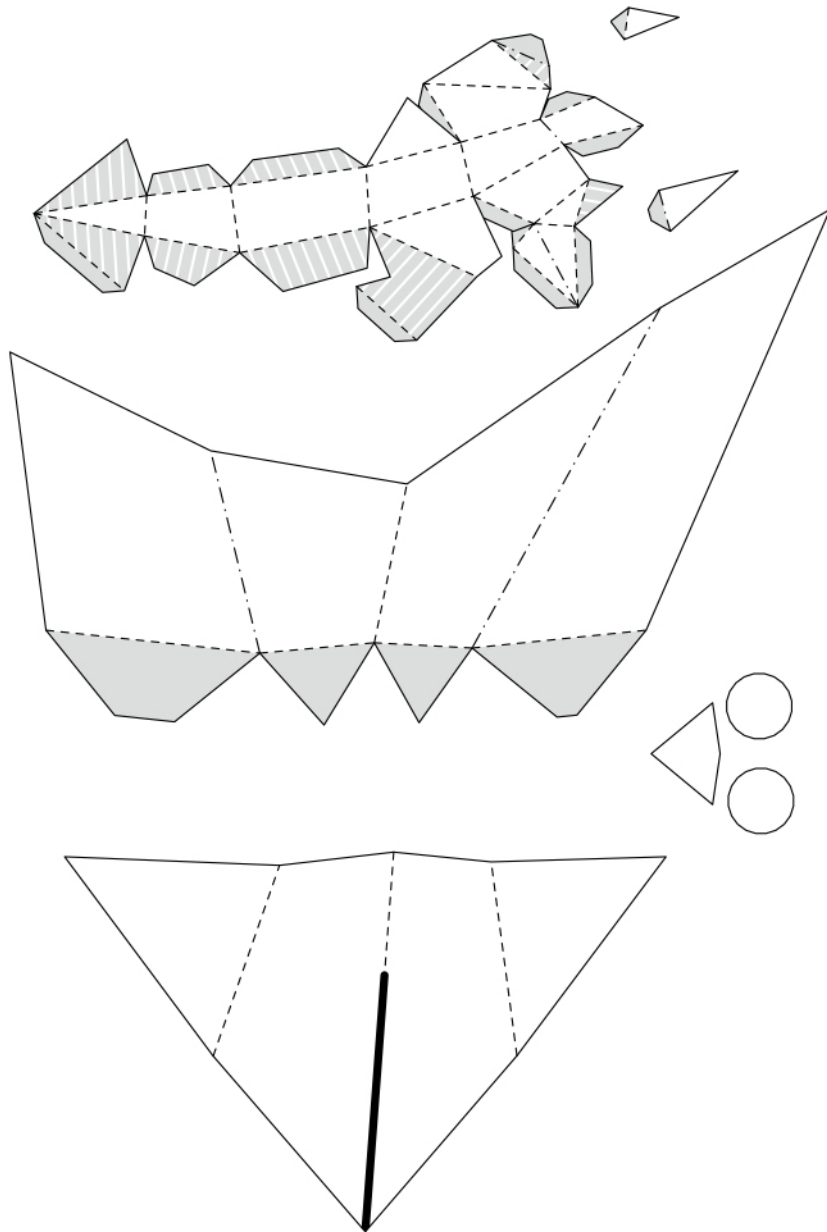

R、L手上臂内側

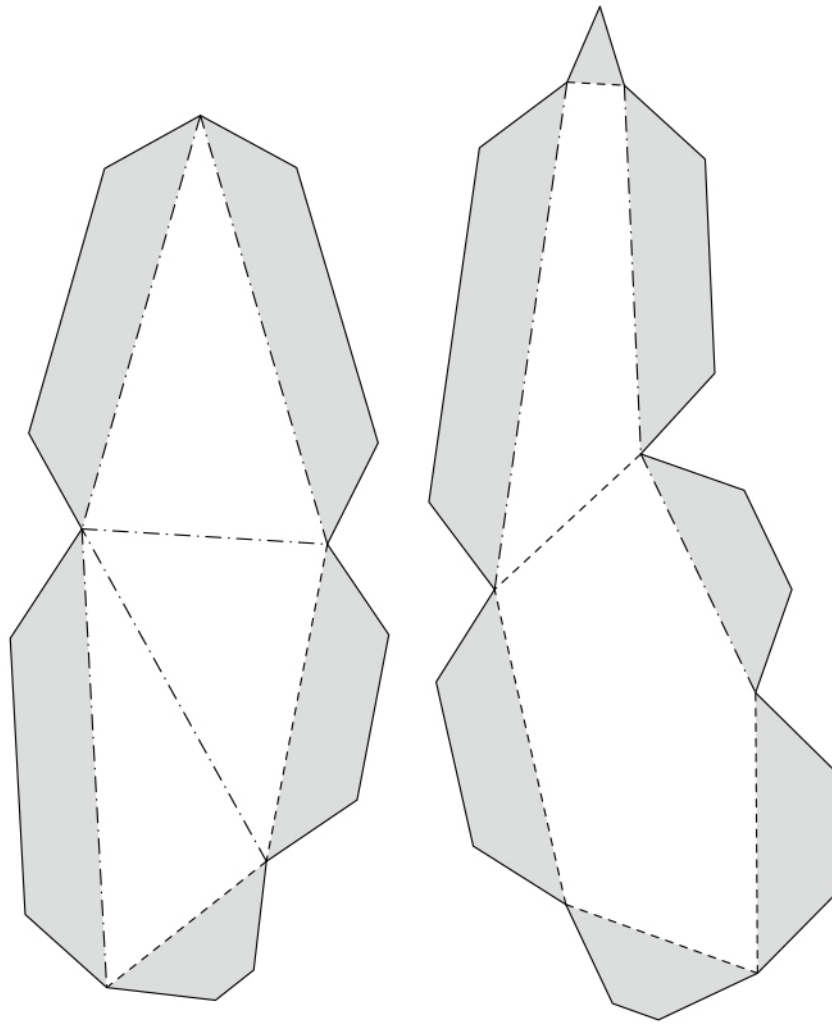

只身

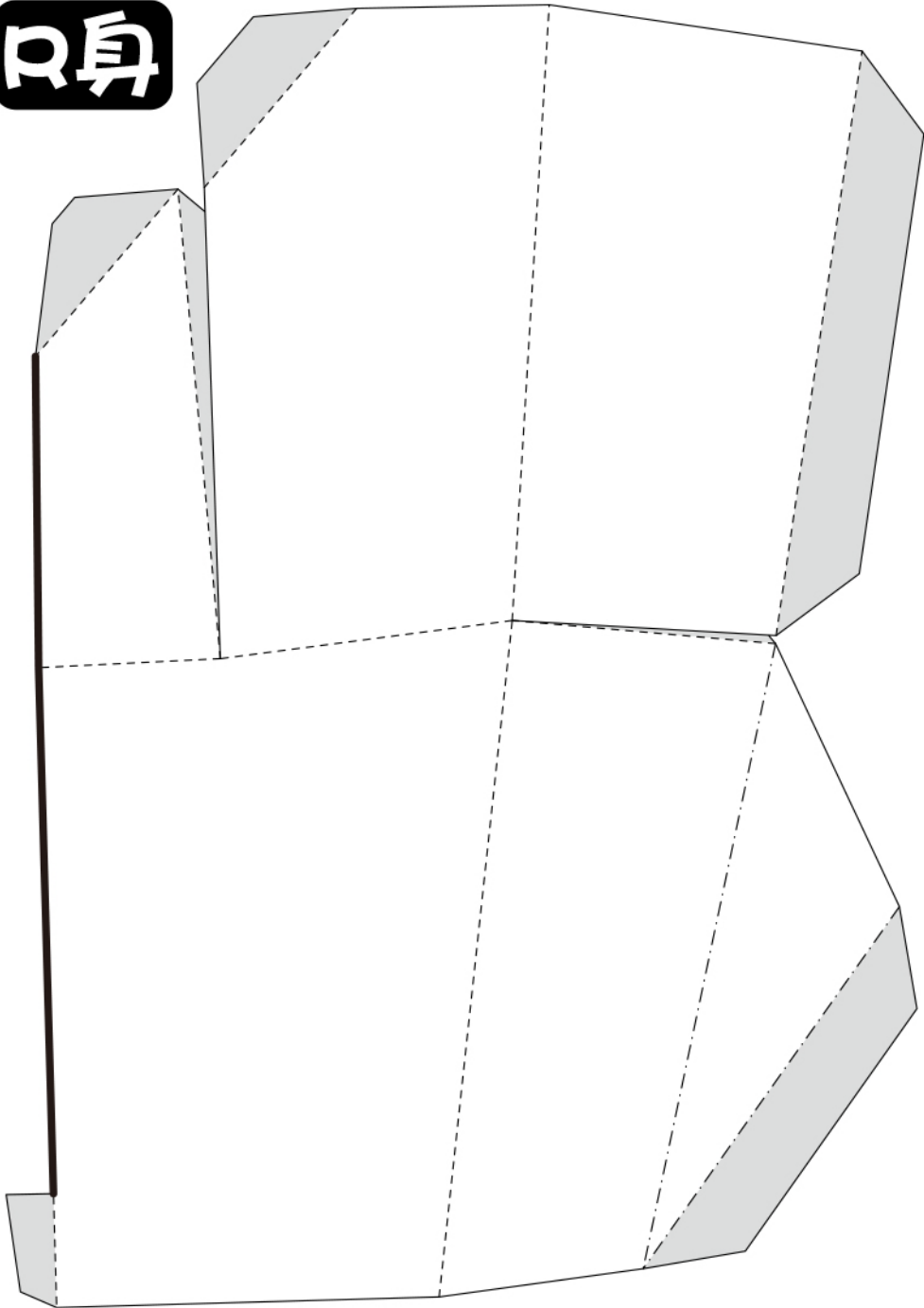

し身

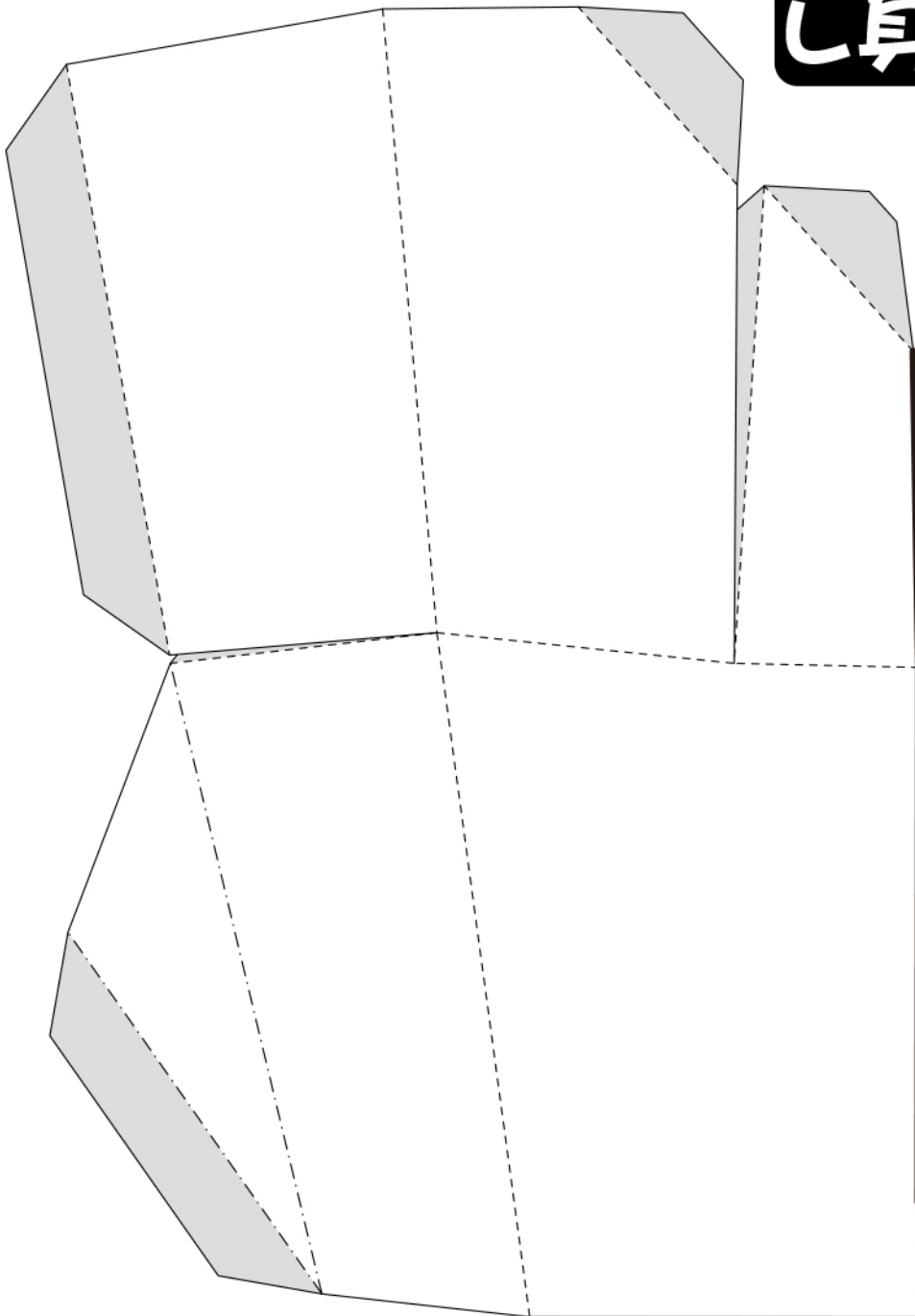

只側腰

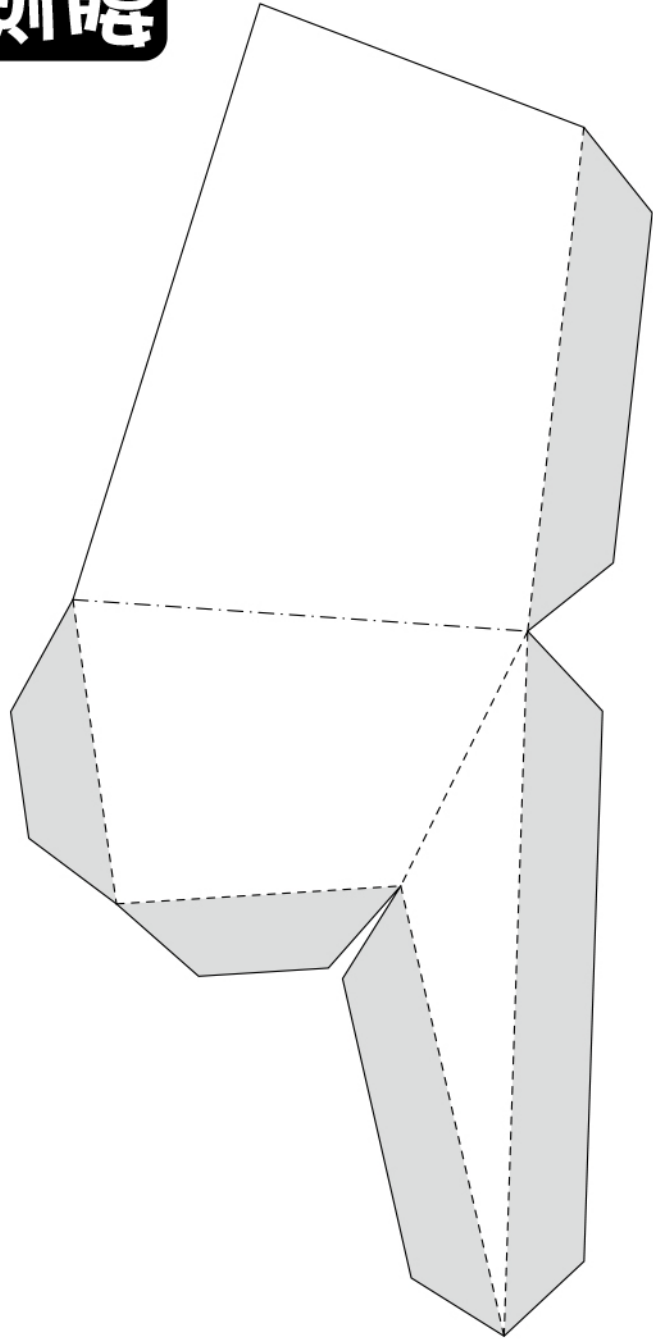

ㄟ側腰

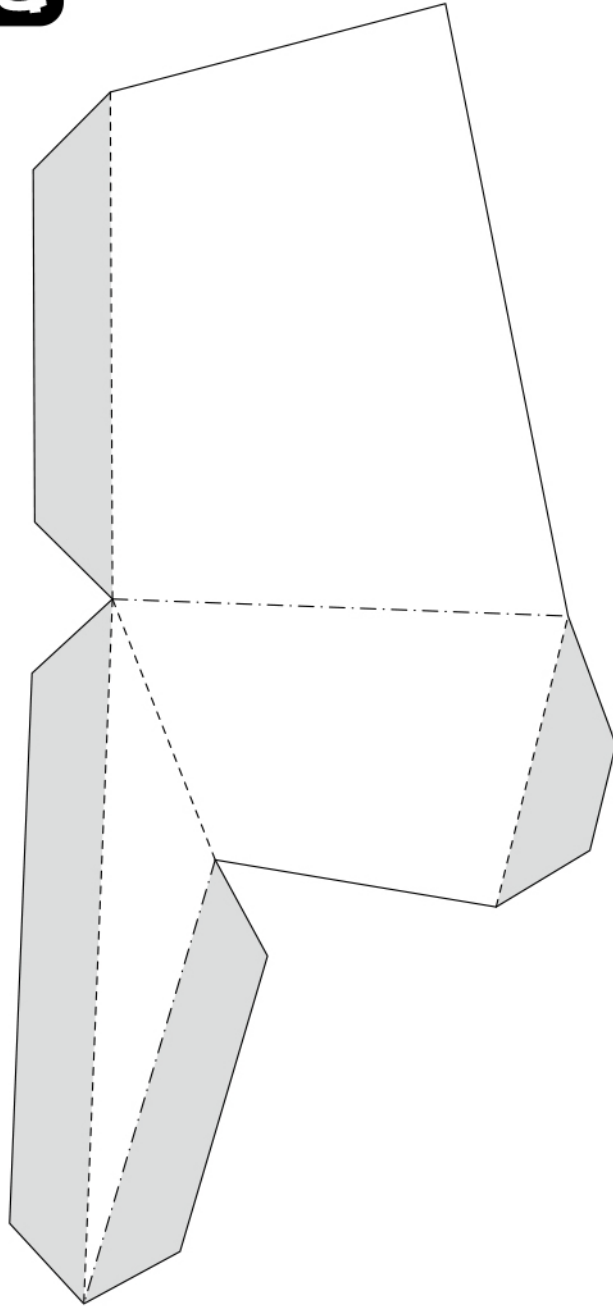

私密部位

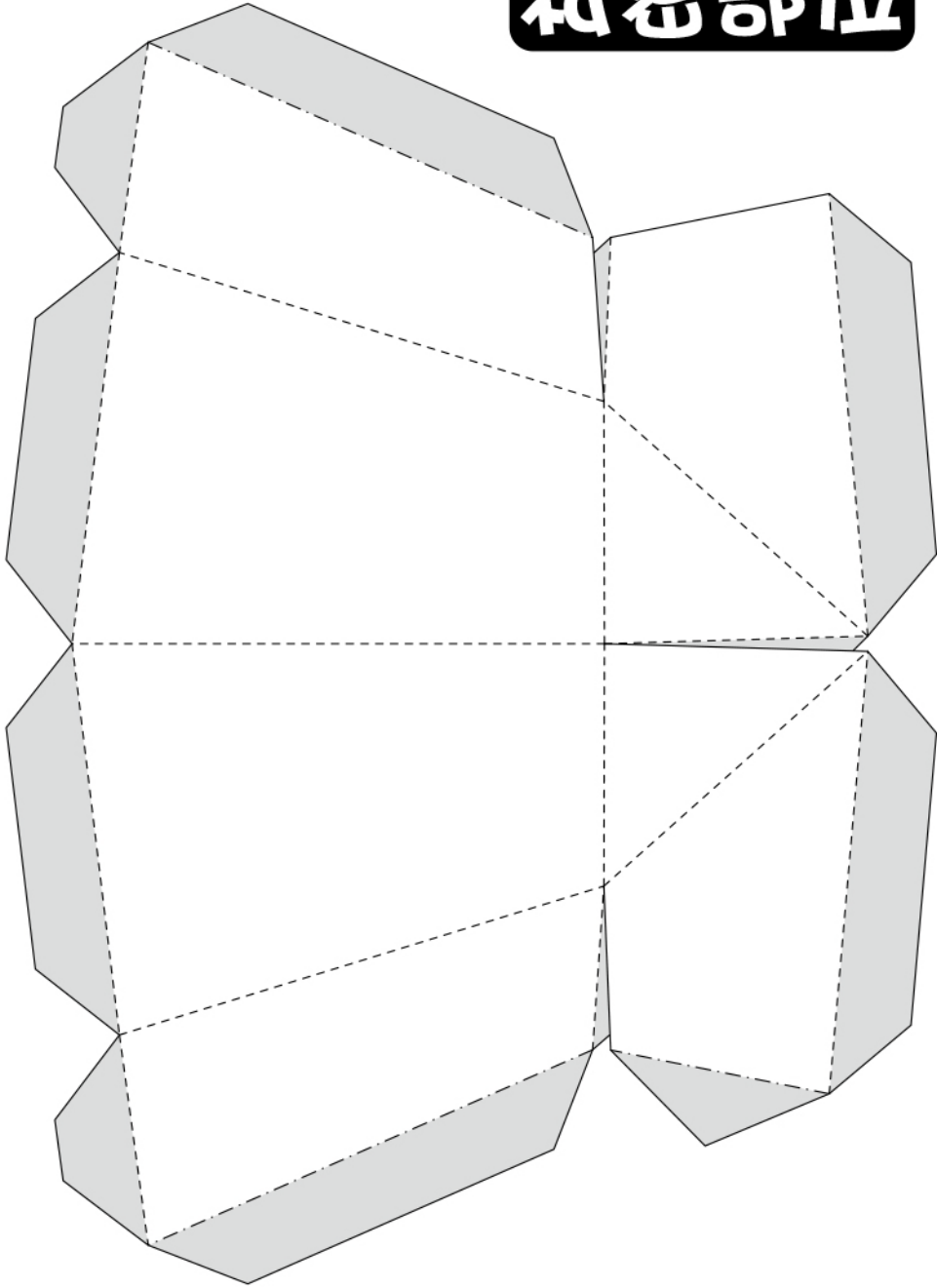

右小腿

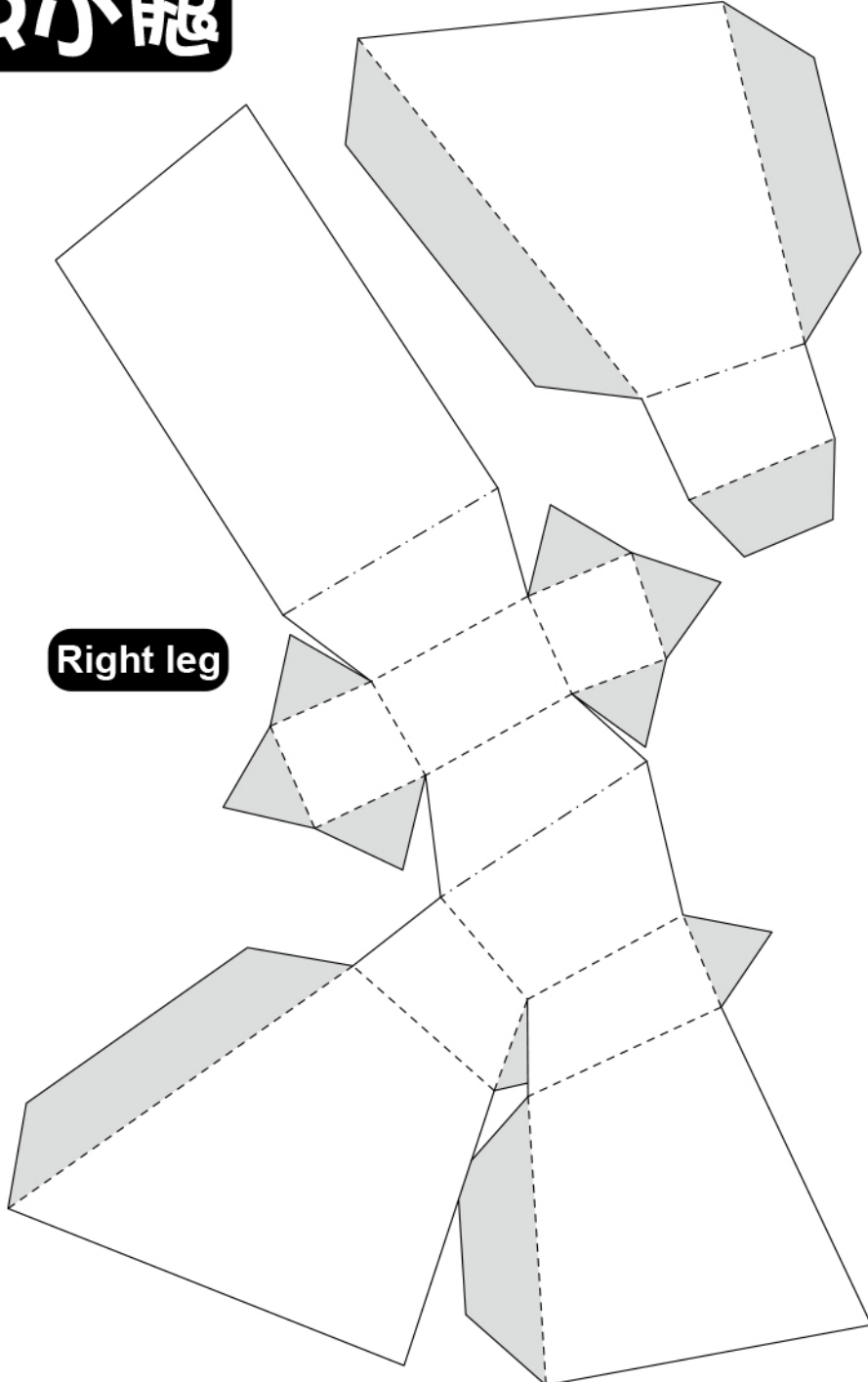

Right leg

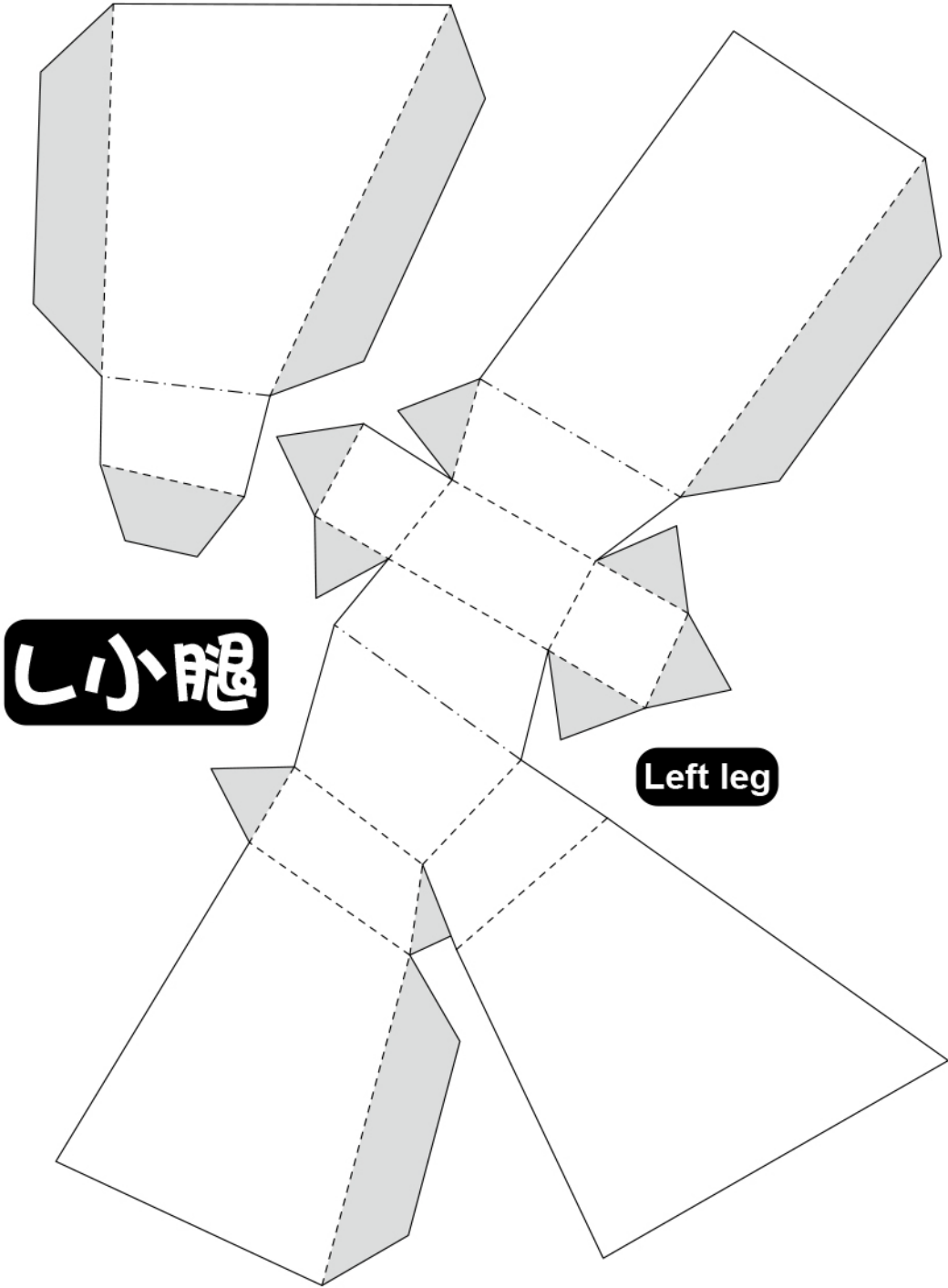

し小腿

Left leg

只膝蓋

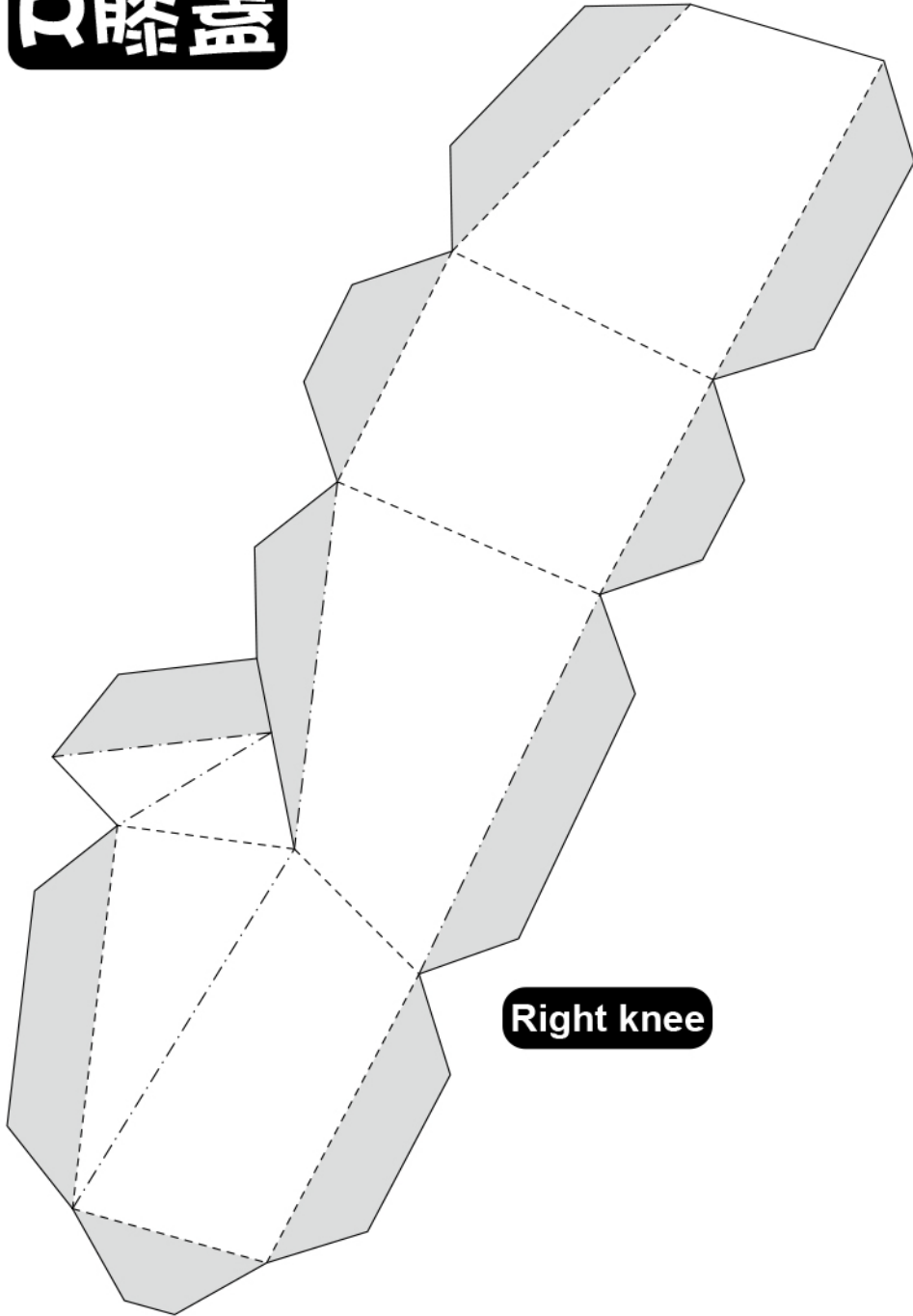

Right knee

膝蓋

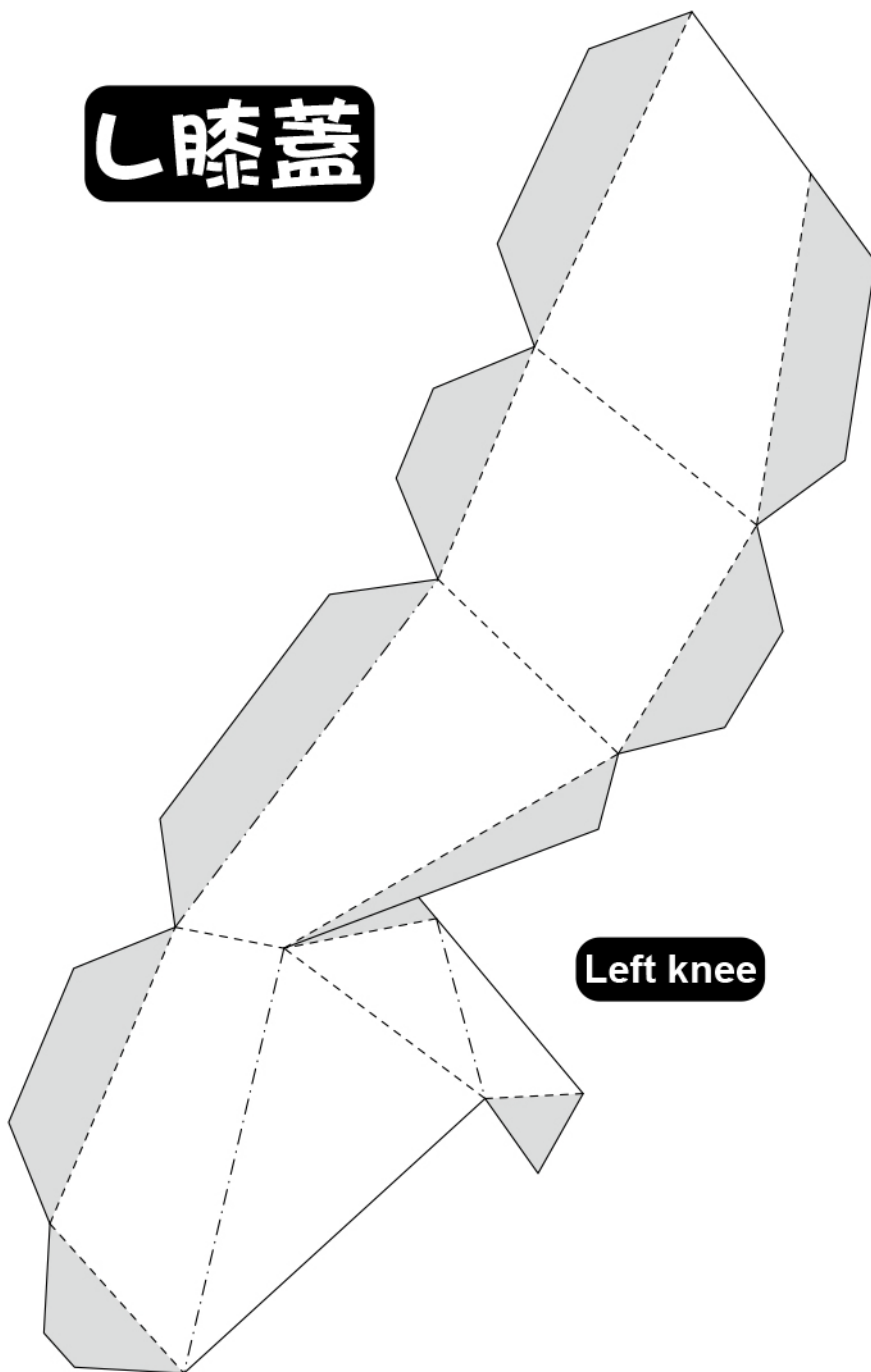

Left knee

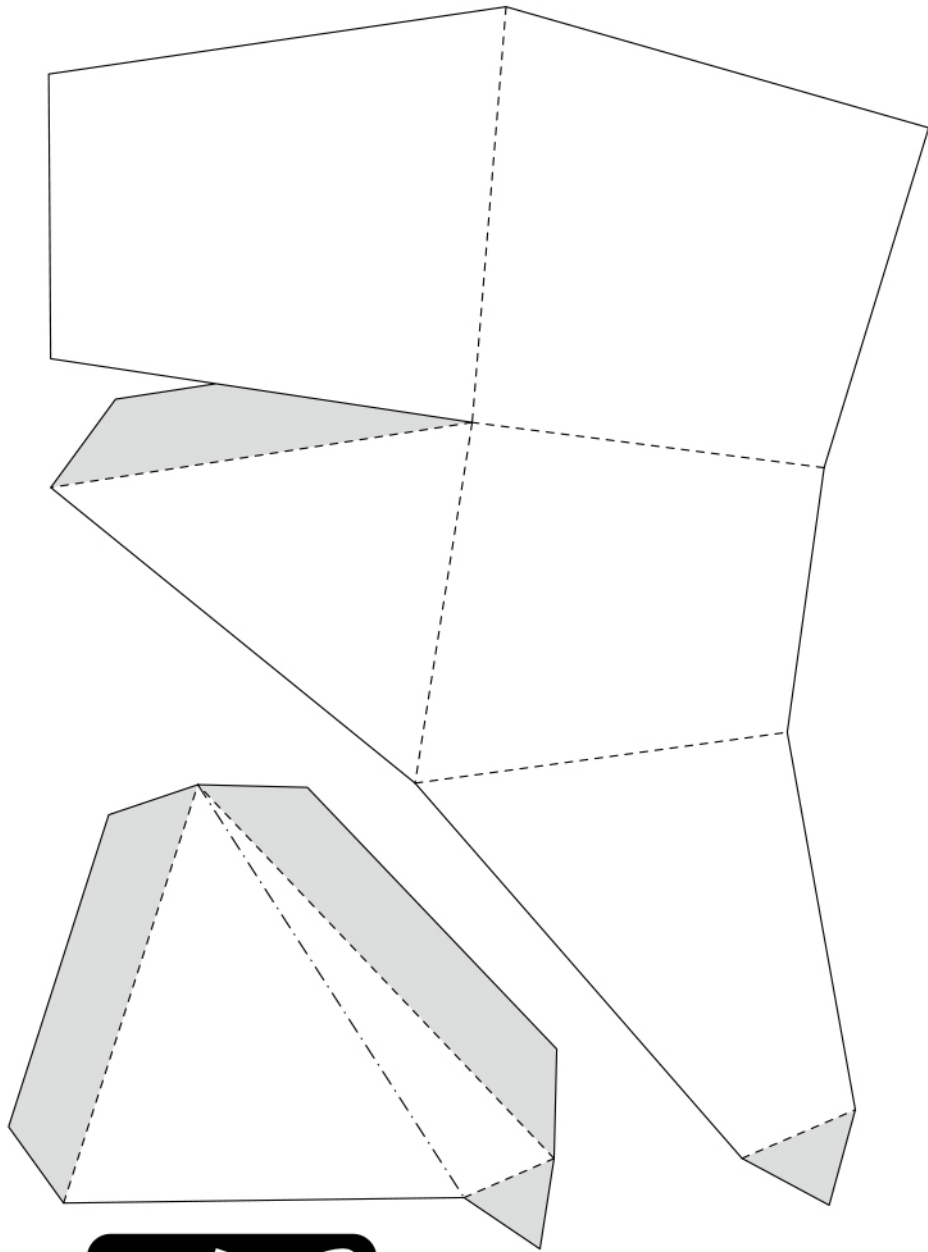

只大腿

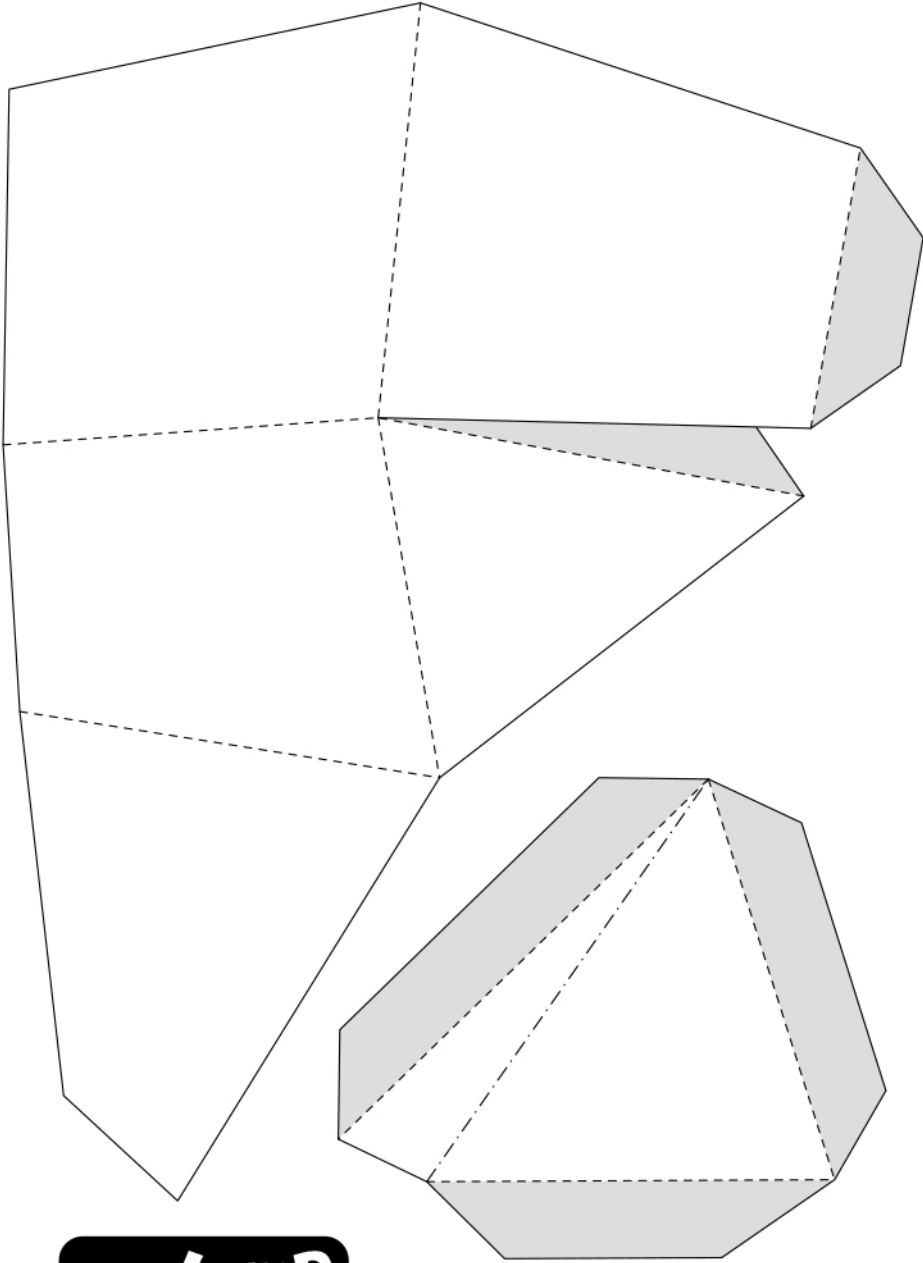

大腿

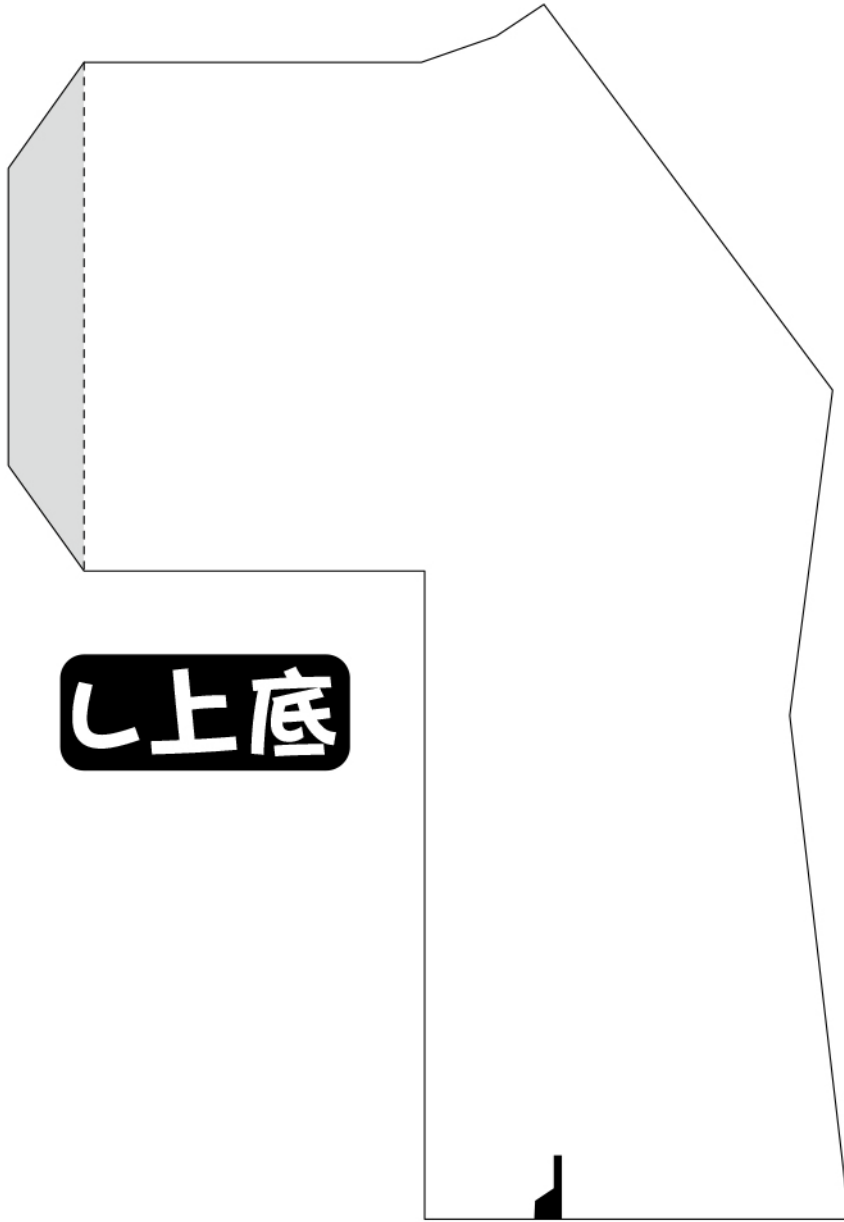

し下底

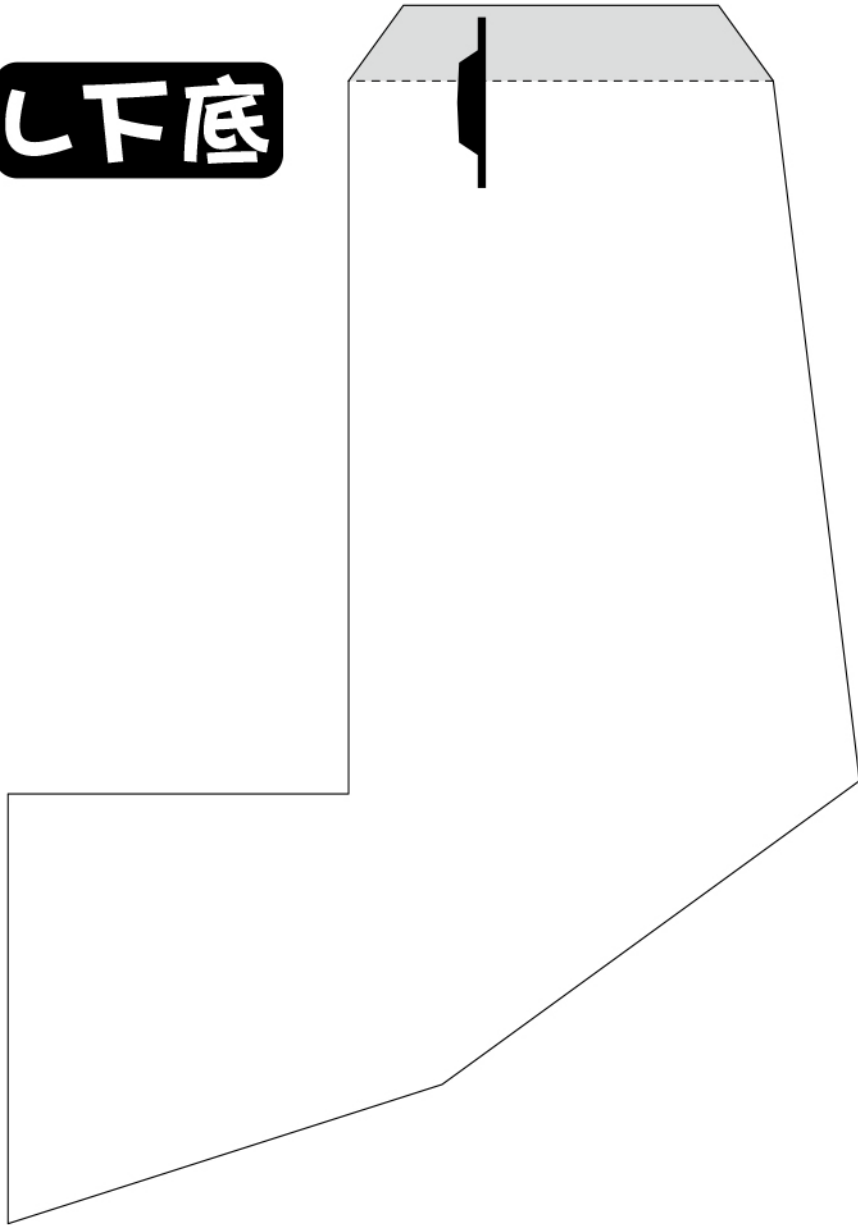

只上底

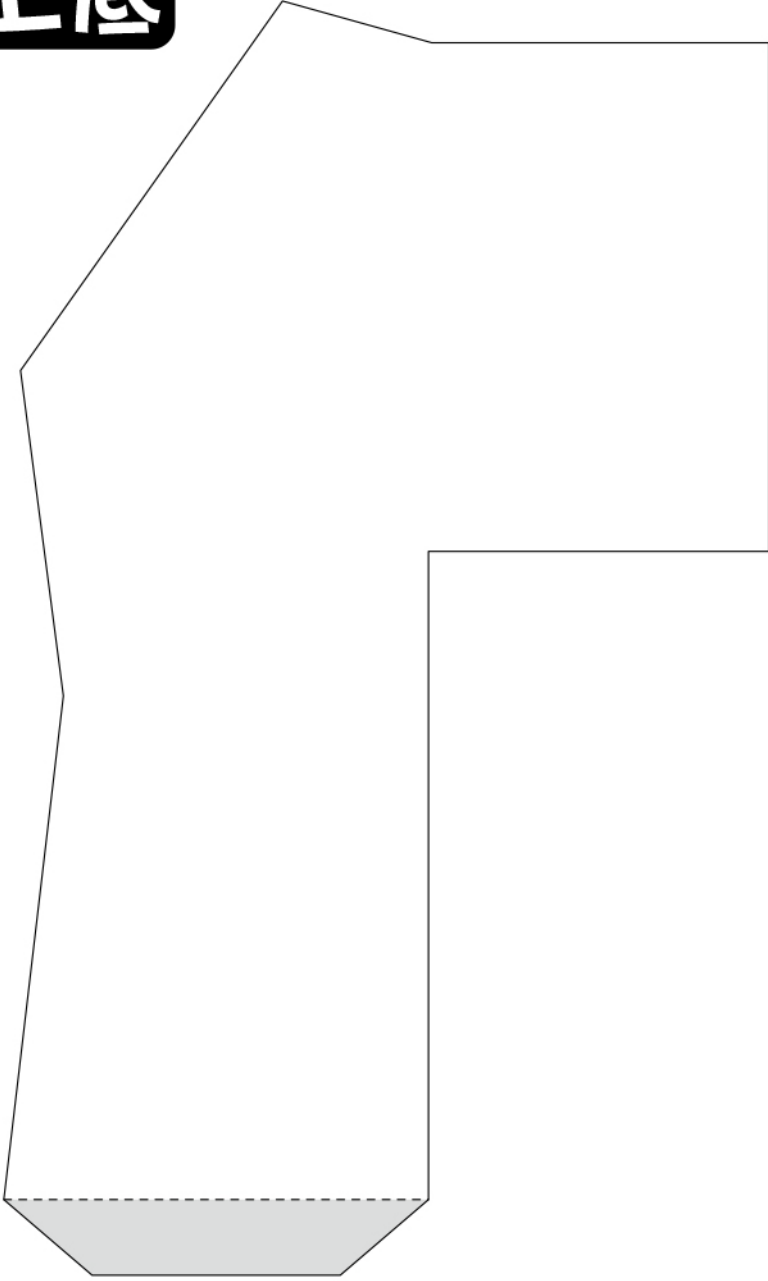

R下底

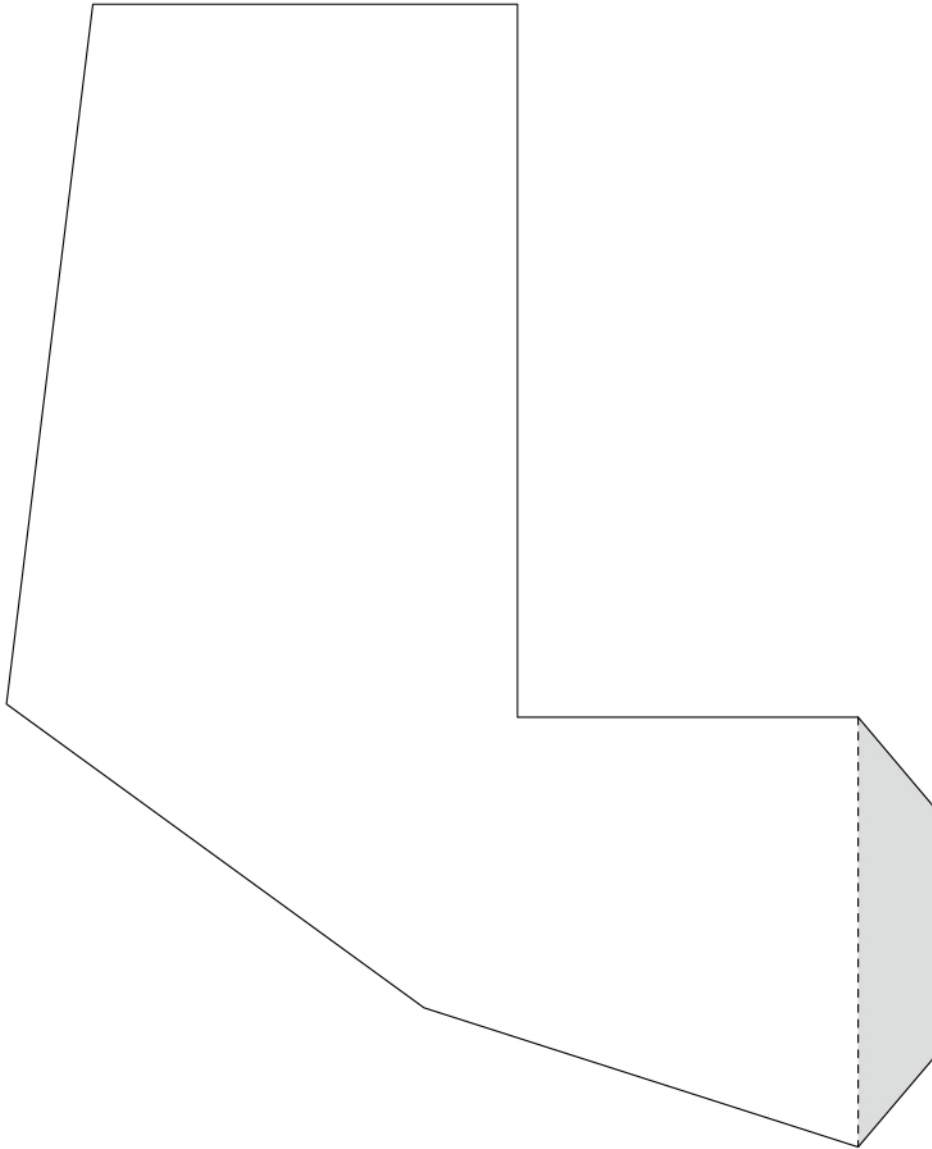

下面的內構

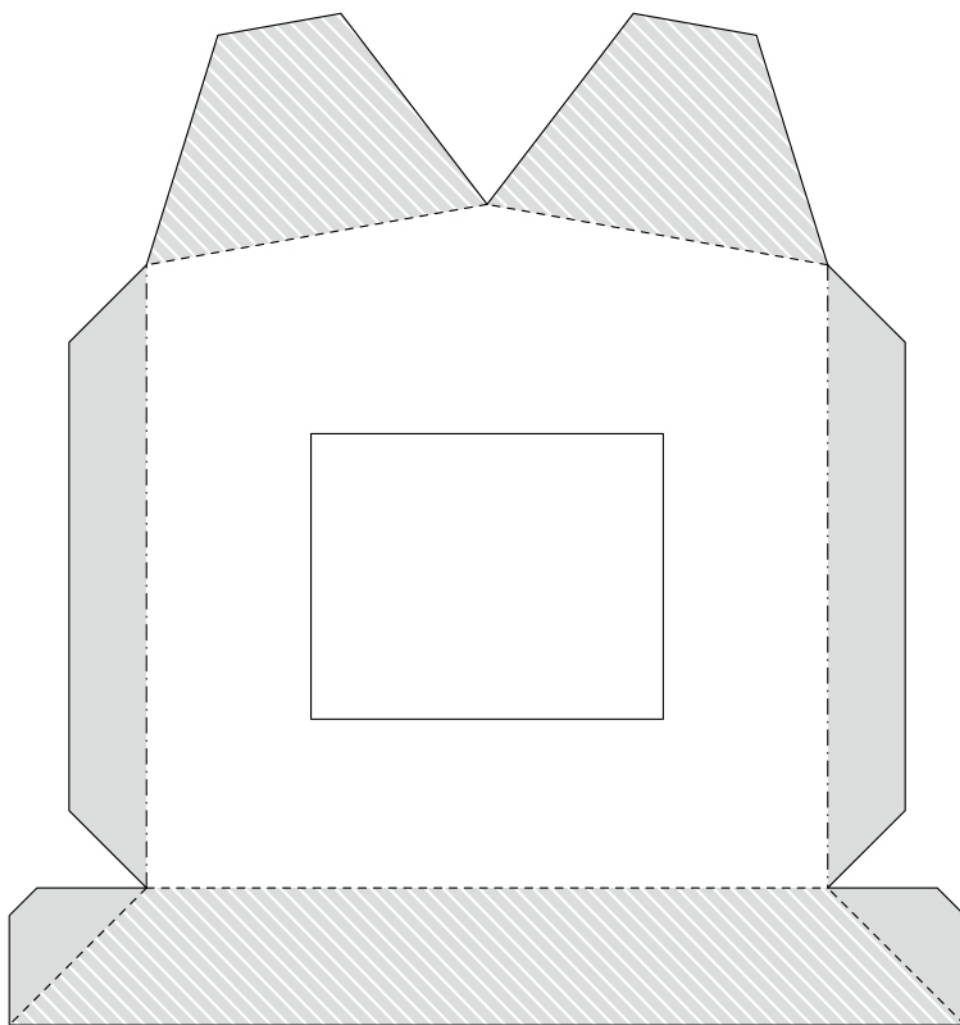

上面的內構

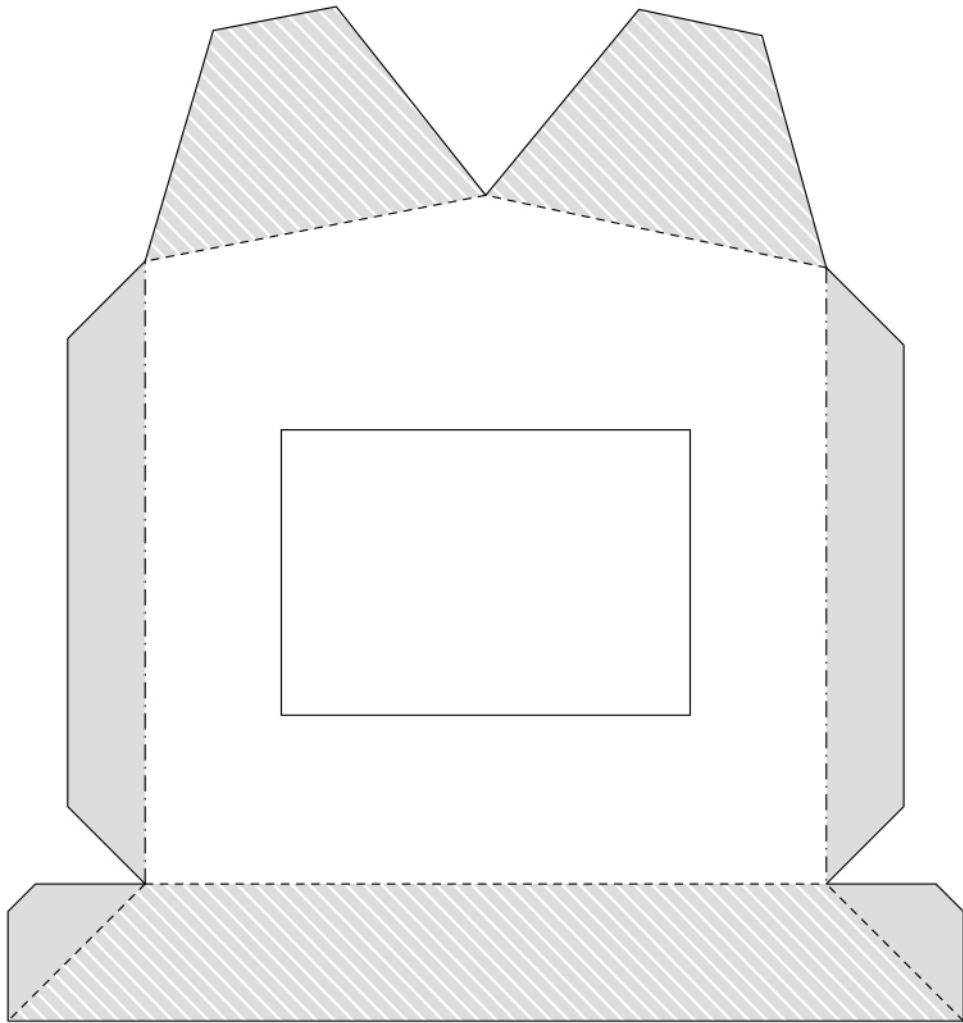

L上的內構

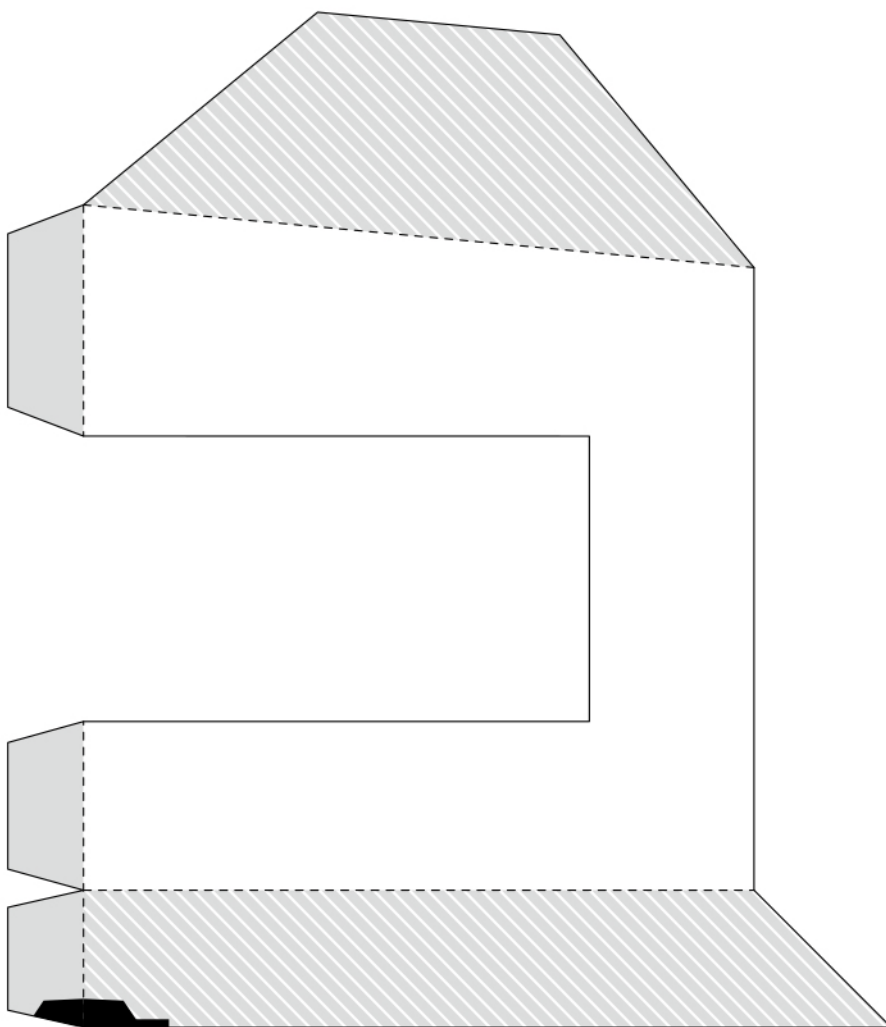

ㄟ下的內構

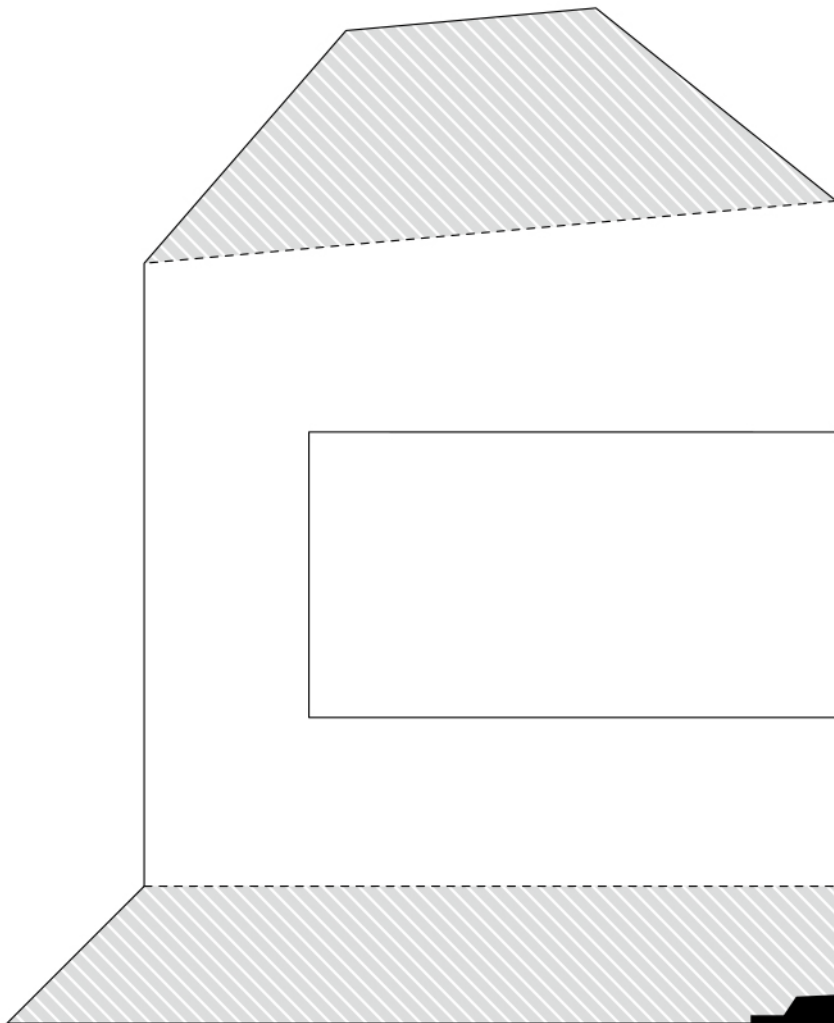

R下的內構

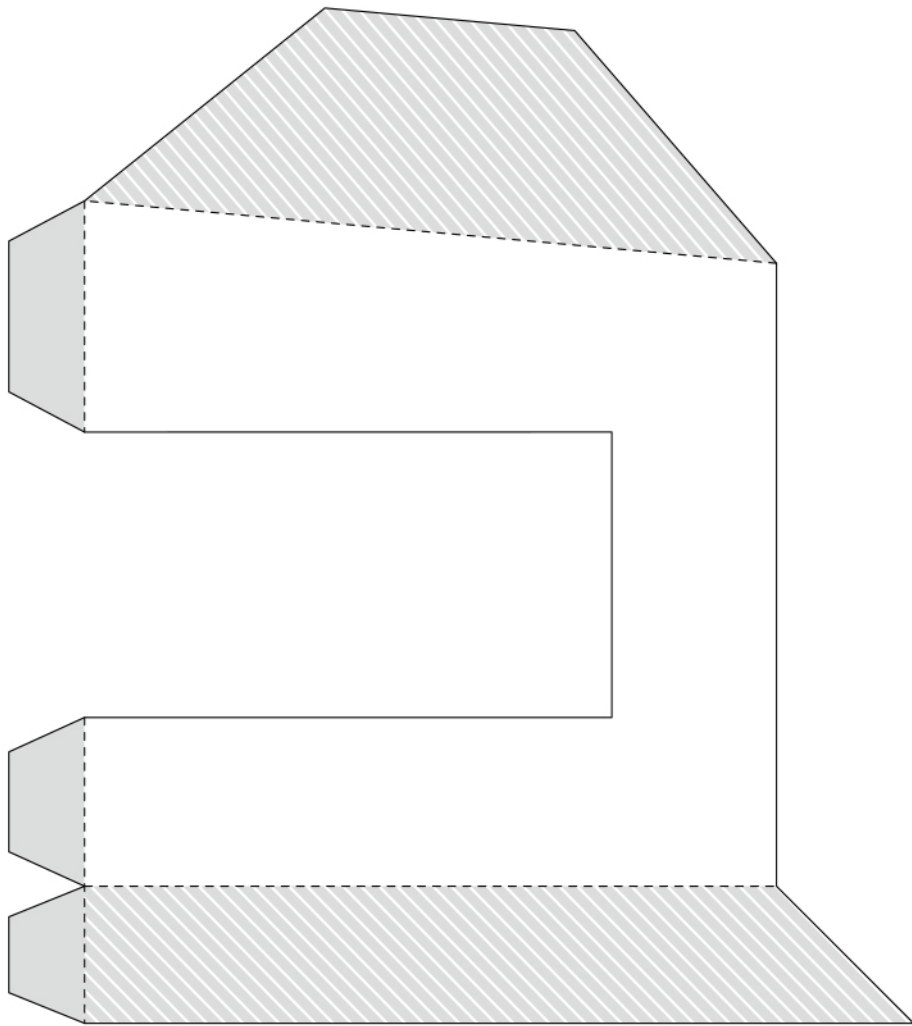

R上的內積

