

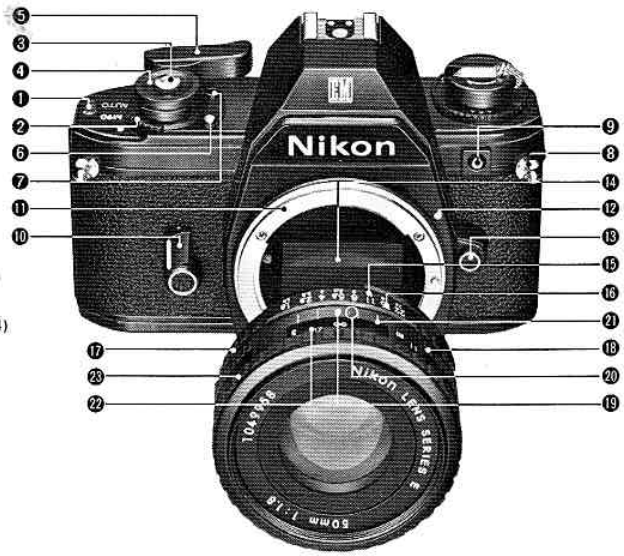

# NOMENCLATURE

- Frame counter
- Shutter operation mode selector (p. 23)
- Shutter release button (p. 21)
- Shutter release fingerguard (p. 19)
- Film winding lever (p. 21)\*
- Battery power check button (p. 12)
- Battery power LED lamp
- Neckstrap eyelet
- Exposure compensation button (p. 10)
- Self-timer (p. 21)
- Lens mounting flange (p. 13)
- Lens mounting index
- Lens release button
- Reflex mirror
- Aperture direct readout (ADR) scale\*\*
- Lens aperture scale
- Lens aperture ring (p. 19)
- Lens mounting ring (p. 13)
- Aperture/distance scale index
- Infrared photography focusing index (p. 24)
- Depth-of-field indicators (p. 25)
- Focusing distance scale (p. 18)
- Lens focusing ring (p. 17)
- Infinity plane indicator (p. 24) positioned below  
lot used with the EM; for Nikon cameras  
with ADR facility



# TABLE OF CONTENTS

	Page No.
<b>I. NOMENCLATURE</b> .....	3, 34
<b>II. BASIC OPERATION</b> .....	4-9
<b>III. HOW TO HOLD THE CAMERA</b> .....	10
<b>IV. SETTING UP THE CAMERA BODY AND THE LENS</b>	
A. Install the Batteries.....	11-12
B. Mount the Lens.....	13
<b>V. PREPARING TO SHOOT AND ACTUAL SHOOTING</b>	
A. Load the Film.....	14-15
B. Set ASA.....	16
C. Focus.....	17-18
D. Determine Exposure.....	19-20
E. Shoot.....	21
F. Unload the Film.....	22
<b>VI. TECHNICAL DETAILS AND OTHER INFORMATION</b>	
A. Exposure Measurement.....	23
B. Shutter Operation Mode Selection.....	23
C. Film Plane Indicator.....	24
D. Infrared Photography.....	24
E. Depth of Field.....	25
<b>VII. SPECIAL ACCESSORIES FOR THE NIKON EM</b>	
A. Motorized Shooting with the Nikon MD-E Motor Drive.....	26-27
B. Flash Photography with the Nikon SB-E Speedlight Unit.....	28
<b>VIII. OTHER EM ACCESSORIES AND USABLE LENSES</b>	
A. Other Accessories.....	29
B. Nikon and Nikkor Lenses for the Nikon EM.....	30
<b>IX. TIPS ON CAMERA CARE</b> .....	31
<b>X. SPECIFICATIONS</b> .....	32-33

# II. BASIC OPERATION

This section provides a concise summary of all the other sections of this manual. After you have thoroughly read the rest of the manual, use this section as a quick reference source.

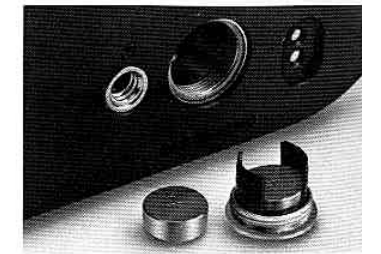

**2.** Insert two batteries into battery compartment.

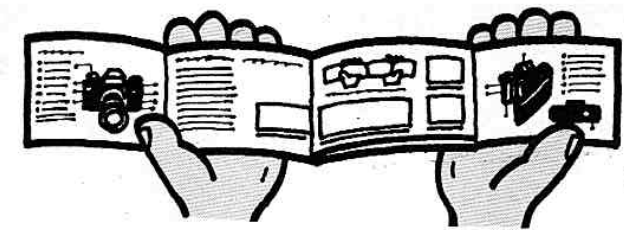

Spread out the manual for ready reference to the numbered nomenclature terms. Details are explained on pages indicated by the numbers in parentheses.

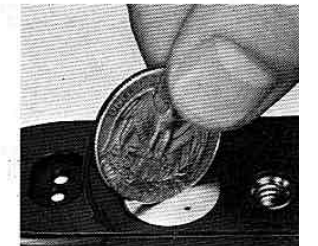

**1.** Unlock battery chamber cover (11-12).

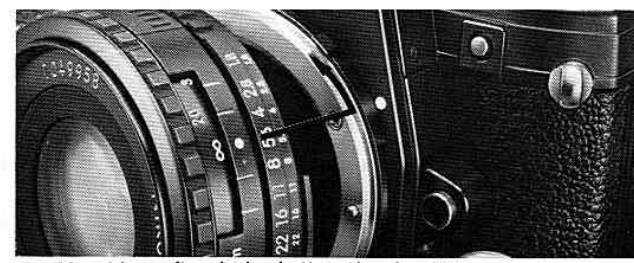

**3.** Mount lens after closing battery chamber (13).

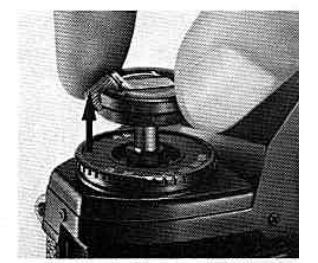

**4.** Pull out film rewind knob (14) to open camera back (14).

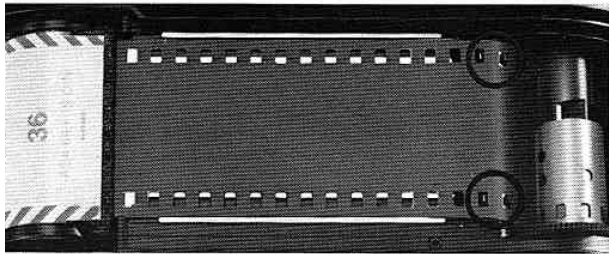

Load film (14-15). To ensure proper film winding, make sure that both edges of the film engage the film sprockets (7).



6. Rotate film rewind crank (2) to take up film slack (14-15). Be careful that you do not wind film back into the cassette.



7. Snap camera back closed, then set ASA with ASA film speed selector ring (2) (16).

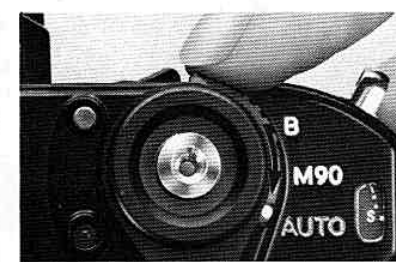

8. Set shutter operation mode selector (2) to AUTO.

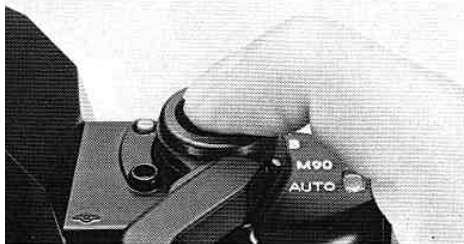

Press shutter release button (3) all the way (21).

Note: Do not attempt to take pictures prior to frame 1, the start of AUTO operation.

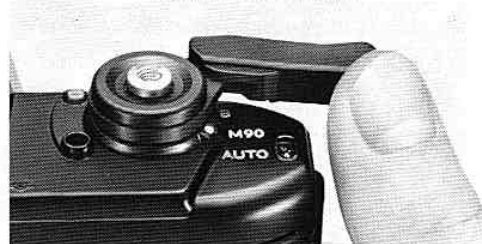

10. Stroke film winding lever (5) to advance film (21).



11. Confirm film advance: film rewind knob (2) turns opposite engraved arrow as winding lever is stroked (14-15).



12. Repeat Steps 9 and 10 until frame counter (1) indicates 1. Camera is then ready to take first picture.



3. Look through viewfinder eyepiece (12), and focus on subject (17-18).



14. Switch meter on, lightly pressing shutter release button (3). Turn lens aperture ring (1) until "beep-beep" sound, if any, stops (20).

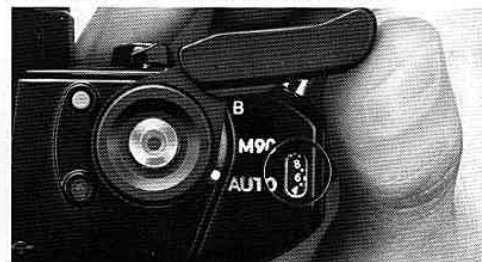

16. Advance film to the next frame. (p. 21).



15. You are now ready to shoot: depress shutter release button until you hear the click of the shutter (21).

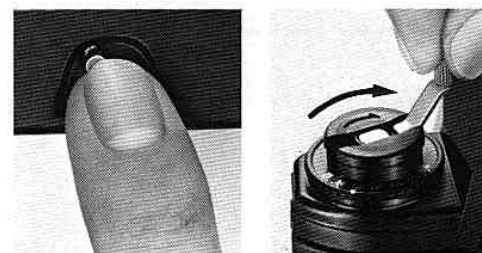

17. After completing the roll, rewind and unload film (22).



### III. HOW TO HOLD THE CAMERA

To take good pictures, you should first learn how to handle your camera properly. Hold the camera with both hands, as shown in the pictures, cushioning it in the palm of your left hand. For added support, prop your left-hand elbow against your body. Before loading the camera with film, practice in front of a mirror until you have mastered all the controls.

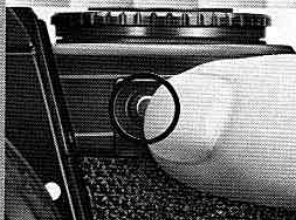
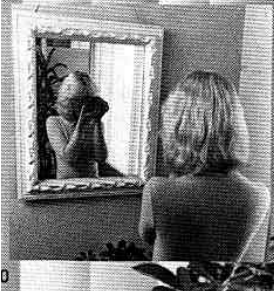

Exposure compensation button ①: Depressed with the left-hand index finger (p.21)

### IV. SETTING UP THE CAMERA BODY AND THE LENS

#### A. Install the Batteries

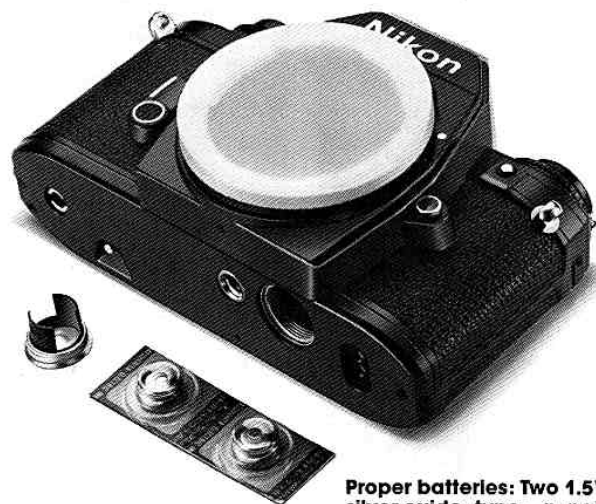

Proper batteries: Two 1.5V silver-oxide type; a pair comes with your camera.

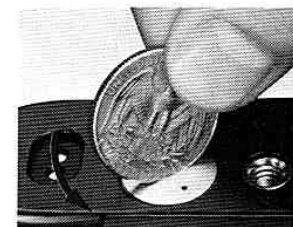

1. Unlock the battery chamber lid ① with a coin.

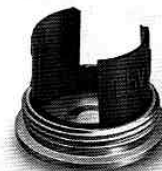

2. Remove the battery clip which is integral with the lid.

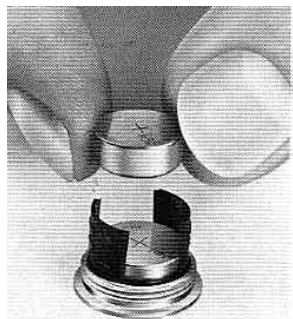

3. Insert the batteries, handling them at the edges, one on top of the other, with the + marks facing up, into battery clip.



4. Replace the battery chamber clip/lid, and close the chamber securely.

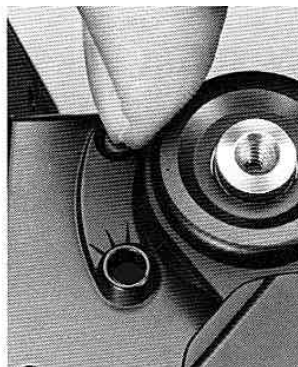

5. Push the battery power clip/button ②. If the adjacent lamp does not light up (or is too dim), check battery orientation or put in a new set of batteries.

#### B. Mount the Lens



Proper lenses: Nikon Series E lenses, AI-type Nikkor lenses and others (p. 30).



1. Remove the camera body cap.

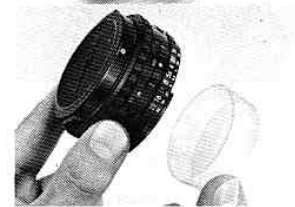

2. Remove the rear lens cap.

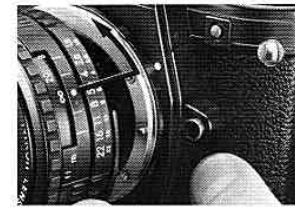

3. Seat the lens on top of the camera body's lens mounting flange ①, making sure the lens mounting index ② is aligned with the aperture/distance scale index ③. Then twist the lens by its mounting ring ④ until it clicks into place.

To remove the lens: Press the camera's lens release button ⑤, and twist the lens by its mounting ring until it becomes loose.

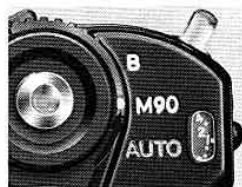

### QA

**Q.** Can I still use the camera even when the batteries are dead?

**A.** Yes. In this case, reset the shutter operation mode selector ② from AUTO to M90 which will provide a shutter speed of 1/90sec.

## V. PREPARING TO SHOOT AND ACTUAL SHOOTING

### A. Load the Film

**Proper film:** Any commercially available, color or black-and-white, 35mm film (negative prints) or transparency slides) in cassettes of 12, 20, 4 or 36 exposures.

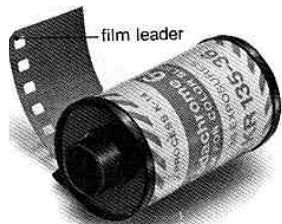

—film leader



**1.** Open the camera back by pulling up the film rewind knob ①.



**2.** Place the cassette in the film cassette chamber ②.



**5.** After closing the camera back, press the shutter release button ③.



**6.** To take up film slack, turn the film rewind crank ④ in the direction of the engraved arrow, until you feel a slight resistance. Be careful not to wind the film back into the cassette.

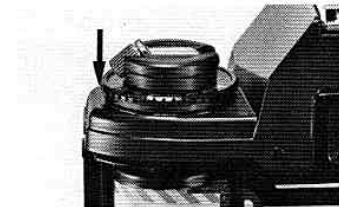

**3.** Secure the cassette with the film rewind fork ⑤ by pressing the knob back.

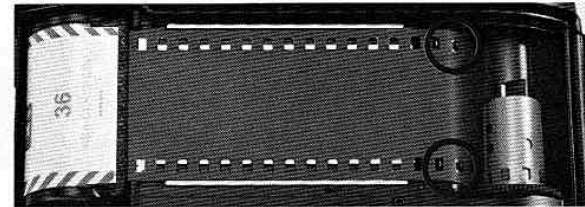

**4.** Insert the film leader into any of the film take-up spool's ⑥ slots. Be sure the film's perforations engage the film sprockets ⑦. Press the shutter release button and stroke the film winding lever to advance the film.

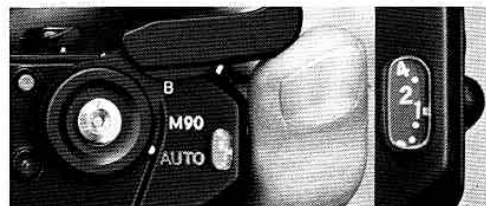

**7.** Advance the film, press the shutter release button, and advance the film again until the frame counter ⑧ indicates 1 to start AUTO operation.



**QA**

**Q.** How can I be sure the film has been properly loaded and is being advanced?

**A.** If, as you advance the film winding lever, the film rewind knob rotates in the opposite direction of the arrow engraved on it, you can be sure the film is being properly advanced.

**Note:** If you release the shutter during "AUTO" operation with the cap mounted on the lens or in an extra dark place, the reflex mirror ⑨ will remain in the "up" position. To return the mirror to its original position, set the shutter operation mode selector ② to M90 or B.

### B. Set ASA

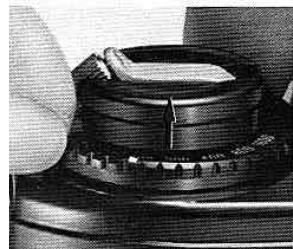

**1.** Pull up the ASA film speed selector ring ①.

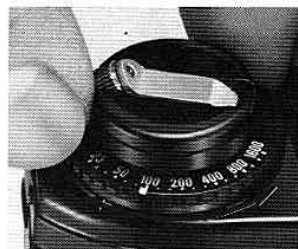

**2.** Turn it until the ASA film speed setting index ② is aligned with your film's ASA rating.



**Note:** Don't forget to reset ASA when you use film with different ASA ratings; otherwise, the film will not be correctly exposed.

**QA**

**Q.** What is ASA?

**A.** ASA is a number assigned to your film by the American Standards Association. This number indicates the relative sensitivity of your film to light. Your camera must have this information to be able to give your film the proper exposure.

**QA**

**Q.** What should I do to remember the ASA rating of the film loaded in the camera?

**A.** As a reminder, insert the film carton tab which indicates the ASA rating, into the camera back's memo holder ④.

### C. Focus



**1.** Aim your camera at your subject, then compose the picture through the viewfinder.



**2.** Rotate the lens focusing ring ② until your subject appears sharp. There are three focusing aids you can use.

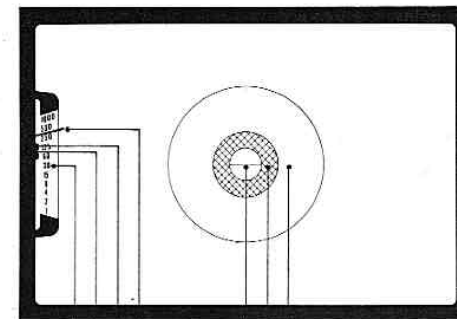

1 2 3 4 5 6 7

1. Shutter speed scale
2. Flash ready-light (p. 28)
3. Flash photography bracket (p. 28)
4. Shutter speed needle
5. Split-image rangefinder spot
6. Microprism ring
7. Fine matte outer field

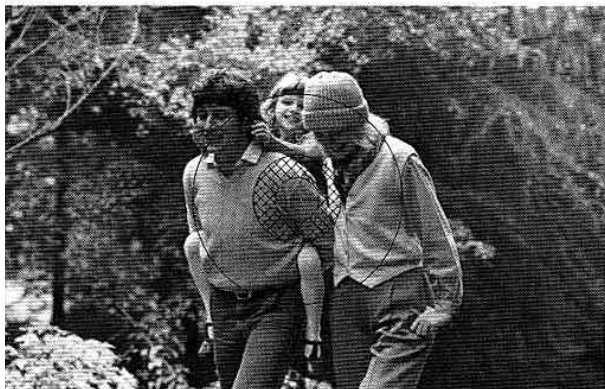

**split-image rangefinder spot:** Suitable for subjects with well-defined outlines. Turn the focusing ring ⑭ until the two halves of the spot coincide, forming a single image.

**microprism ring:** For subjects without definite contours, or for rapid focusing. Turn the focusing ring until the image in the ring appears isp.

**fine matte outer field:** Ideal for close-ups or when shooting with telephoto lenses. Turn the focusing ring until the image in the field appears sharp.



To "prefocus" the lens (i.e., when time does not permit focusing through the viewfinder), turn the focusing ring until the estimated distance is aligned with the lens aperture/distance scale index ⑩. With this technique, however, the focus may not be as sharp as you expect.

**Note:** When you're using lenses with small maximum apertures (e.g., f/5.6, f/8) or taking close-ups, you may find it difficult to focus with the split-image spot or microprism ring (i.e., they become "dark"); in this case, focus with the fine matte outer field.

## D. Determine Exposure



1. Set the shutter operation mode selector ② to AUTO.



2. Select an aperture by turning the lens aperture ring ⑦.

3. Press the shutter release button ⑤ halfway (i.e., cushion your finger with the shutter release fingerguard ④) to switch the camera's meter on. The shutter speed indicated by the needle in the viewfinder will depend on both the selected aperture and scene brightness.

**Note:** The meter remains switched on for a brief period even after your finger is lifted off the shutter release button.

**Exposure warning signal:** Should a "beep-beep" sound be emitted, note the position of the needle in the shutter speed scale. If it swings past 1/1000sec. and stays within the red zone, overexposure will result. In this case, reset lens aperture until the sound stops or the needle "drops" from the red zone; despite the sound, correct exposure is possible. If the needle is around 1/30sec. or below, the sound merely warns you that camera shake may affect image sharpness because of the slow shutter speed. You either readjust aperture until the sound stops, or, if the needle is below 1/30sec., use a tripod to prevent picture blur. The meter remains switched on for a brief period even after your finger is lifted off the shutter release button.

**Notes:** 1. At approximately 1/1000sec. or 1/30sec., a shrill sound may be emitted; it becomes regular when the needle goes beyond these points.  
2. It is possible you won't hear the warning sound in noisy shooting situations.



Overexposed (Above 1/1000 sec.)

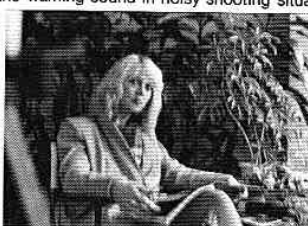

Tripod recommended to prevent camera shake (Below 1/30 sec.)



Correctly exposed

**QA** Q. What shutter speed is best to use?

**A.** The shutter speed should be fast enough to prevent camera shake, especially in hand-held shooting. In dim light, you may not be able to get a high speed. As a rule of thumb, use a tripod if the shutter speed is slower than a number equal to the focal length of the lens. For example, with a 50mm lens,

don't take hand-held pictures at shutter speeds slower than 1/50sec., and with a 135mm, try to use a minimum speed of 1/135sec. Remember, this presumes your subject is not moving. If it does, you'll need faster speeds—in which case you just open the lens aperture.

## E. Shoot

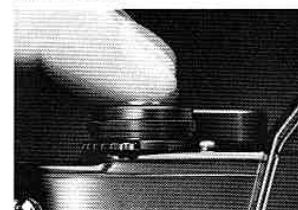

1. Depress the shutter release button ⑤ with steady, even pressure.



2. Advance the film to the next frame by stroking the film winding lever ⑥.

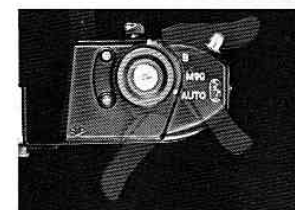

You can move the grooved film winding lever with your right hand thumb in one sweep or a series of short strokes.



**QA**

Q. When is the exposure compensation button ⑨ used?

**A.** To obtain a correct exposure when the main subject is side-lit or backlit. In this case, keep the button depressed as you depress the shutter release button ⑤, the shutter speed needle "drops" by about 2 steps (i.e., from 1/250 sec. to approx. 1/60 sec.).



**Self-timer:** This provides an approx. 10-sec. exposure delay. Slide the lever away from the lens as far as it will go, cover the finder eyepiece ⑫ with the palm of your hand to prevent stray light from entering, then depress the shutter release button. Not

that the timer is designed not to cock accidentally and requires slight pressure when you start to stroke it. After use, gently nudge the lever back into place since it always stops just before the starting position.

## F. Unload the Film

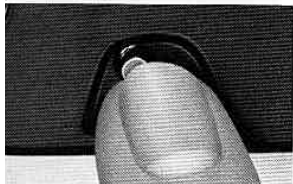

1. When you can no longer stroke the film winding lever ⑤ and the frame counter ① indicates that the last exposure has been made, press the film rewind button ④. Don't force the lever, or you may tear the film out of the cassette.



2. Turn the film rewind crank ② in the direction of the engraved arrow with even pressure until rewind "tension" gets lighter.



3. Pull up the film rewind knob ③ to open the camera back, and remove the cassette.



**Notes:** 1. Do not push the film rewind button before all the frames are exposed; otherwise, there will be a slight frame overlap. If the button is inadvertently depressed, make a blank exposure in a dark place.

2. When carrying the camera, it is recommended that you set the shutter operation mode selector ② from AUTO to B to prevent battery power drainage caused by the shutter release button being inadvertently depressed.



### QA

**Q.** What should I do if I make the mistake of opening the camera back before the film is fully rewound?

**A.** Quickly snap the camera back closed. You may be able to save a few frames, but this is not guaranteed, especially if the back is opened in bright light.

## C. Film Plane Indicator

This is mainly used in close-up photography to determine the exact subject-to-film plane distance. It is visible when the film winding lever ⑤ is pulled out, and positioned precisely on the film plane—16.5mm from the front surface of the lens mounting flange ①.



## D. Infrared Photography

Both Nikon Series E and Nikkor lenses have an infrared photography focusing index ② for shooting with black-and-white infrared film. The image is first focused through the viewfinder; then the lens focusing ring ③ is turned until the point focused is aligned with the infrared index.

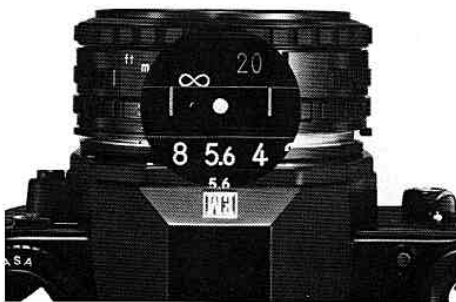

## VI. TECHNICAL DETAILS AND OTHER INFORMATION

### A. Exposure Measurement

The Nikon EM's built-in exposure meter use Nikon's through-the-lens (TTL) center-weighted exposure metering system. The meter "reads" the light over the entire focusing screen, but favors the central 12mm-diameter area outlined on the screen. This is where the main subject is likely to be positioned, and allows the photographer to make precise exposure readings of the selected subject area, as well as provides for overbalanced exposures.

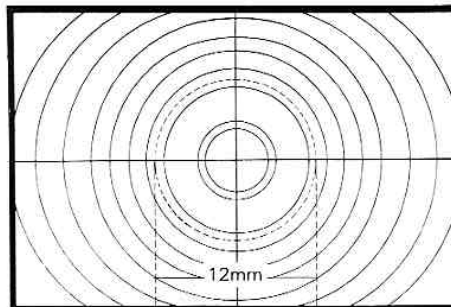

### B. Shutter Operation Mode Selection

The shutter operation mode selector has two mechanical override settings. **M90** provides shutter speed of 1/90 sec.; it is also used for flash photography with an electronic flash unit other than the Nikon SB-E or SB-10 (p. 28). **B** is for long exposures—the shutter curtains remain open for as long as the shutter release button ③ is kept depressed. A tripod is essential for B exposures.



## E. Depth of Field

When you focus on your subject, you will find that objects both in front of and behind it also appear to be in focus. This "zone" of focus is called depth of field. In general, to control depth of field, use the lens aperture ring ① selectively, remembering that the lower the number of the aperture set (i.e., the wider the lens aperture), the "shallower" the depth of field, and vice versa. You can also use the color-coded depth-of-field indicators ② of Nikon Series E and Nikkor lenses. The wider the gap between two identical colors (which match the color of the lens aperture number in use), the deeper the depth of field, and vice versa. Remember, when selecting an aperture based on depth of field, the shutter speed will change accordingly. Be careful that you don't use a shutter speed which is too slow for hand-held shooting or for moving subjects.



Lens set at f/1.8



Lens set at f/8

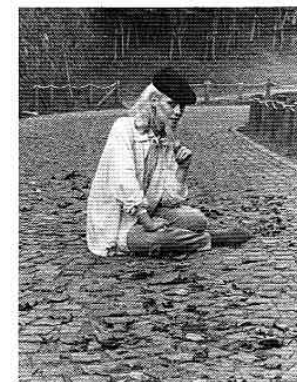

Lens set at f/16

## VII. SPECIAL ACCESSORIES FOR THE NIKON EM

### A. Motorized Shooting with the Nikon MD-E Motor Drive

You don't have to be a pro to discover the excitement of motor-drive photography. The EM's special, equally compact and handsome accessory, the MD-E, makes motorized shooting easy for everyone. You have a choice of single-frame shooting or continuous shooting of up to about two frames per second. A red LED (light emitting diode) lamp at the back of the MD-E flashes to indicate that motorized shooting is in progress. And the motor automatically stops when all the frames have been exposed. It's that simple! Once you put on the motor you probably won't want to take it off! It's a natural accessory for all-around use.

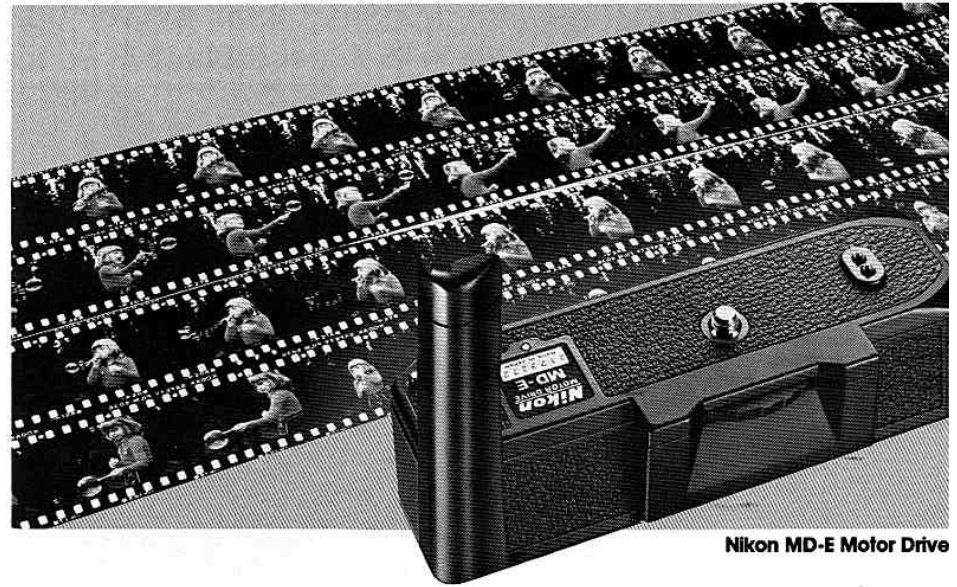

Nikon MD-E Motor Drive

### B. Flash Photography with the Nikon SB-E Speedlight Unit

Slide the compact Nikon SB-E into your camera's recessed ISO-type flash unit hot-shoe, and take great flash pictures automatically—at a predetermined shutter speed of 1/90 sec., with the shutter operation mode selector on AUTO. It's so easy anyone can do it. A "ready-light" inside the camera's viewfinder lets you know when you're ready to shoot. Note that the flash photography bracket inside the viewfinder indicates a flash synchronization speed of 1/90 sec., no matter where the shutter speed needle is positioned. The SB-E provides features that no other flash can. It's the natural choice. It's compact enough to fit in a shirt pocket and really efficient. See it at your Nikon dealer. For flash photography with other electronic flash units, the shutter operation mode selector is set to M90.



## VIII. OTHER EM ACCESSORIES AND USABLE LENSES

### Other Accessories



#### Camera Case

The CF-11 Camera Case is recommended for storing the Nikon EM with a Nikon Series E 50mm f/1.8 mounted. It has an attractive, durable finish.



#### Eye-piece Adapter

Simply slide this adapter onto the EM's rectangular viewfinder eyepiece, and you can use various Nikon viewfinder accessories, such as eyepiece correction lenses, rubber eyecup, etc., to meet the requirements of various shooting situations.



#### Lens Hoods

The HR-4 and HR-4 Lens Hoods perfectly complement the Nikon Series E lenses. They prevent extraneous light from striking the lens surface and causing flare and ghost in the picture. Also useful for protecting the lens.

#### Compartment Case

The FB-E Compartment Case has been specially designed to accommodate the Nikon EM with a Nikon Series E 50mm f/1.8 lens attached and other EM accessories such as Nikon Speedlight SB-E, Nikon Motor Drive MD-E, Nikon Series E 35mm f/2.5, 100mm f/2.8 and sundry items.



## ikon and Nikkor Lenses for the Nikon EM

### on Series E Lenses

on Series E 50mm f/1.8  
on Series E 35mm f/2.5  
on Series E 100mm f/2.8

### kor Lenses

ideangle)  
Nikkor 13mm f/5.6  
Nikkor 15mm f/5.6  
Nikkor 18mm f/4  
Nikkor 20mm f/3.5  
Nikkor 24mm f/2  
Nikkor 24mm f/2.8  
Nikkor 28mm f/2  
Nikkor 28mm f/2.8  
Nikkor 28mm f/3.5  
Nikkor 28mm f/3.5  
Nikkor 35mm f/1.4  
Nikkor 35mm f/2  
Nikkor 35mm f/2.8  
ormal)  
Nikkor 50mm f/1.2  
Nikkor 50mm f/1.4  
Nikkor 50mm f/1.8  
Nikkor 50mm f/2  
ephoto)  
Nikkor 85mm f/2  
Nikkor 105mm f/2.5  
Nikkor 135mm f/2  
Nikkor 135mm f/2.8  
Nikkor 135mm f/3.5  
Nikkor 180mm f/2.8  
Nikkor 200mm f/4  
Nikkor 300mm f/2.8 IF-ED  
Nikkor 300mm f/4.5 IF-ED

✗ Nikkor 300mm f/4.5  
✗ Nikkor 400mm f/3.5 IF-ED  
✗ Nikkor 400mm f/5.6 IF-ED  
✗ Nikkor 400mm f/5.6 ED  
✗ Nikkor 600mm f/5.6 IF-ED  
✗ Nikkor 800mm f/8 IF-ED  
✗ Nikkor 1200mm f/11 IF-ED (Reflex)  
Reflex-Nikkor 500mm f/8  
Reflex-Nikkor 1000mm f/11  
Reflex-Nikkor 2000mm f/11 (Zoom)  
✗ Zoom-Nikkor 28-45mm f/4.5  
✗ Zoom-Nikkor 35-70mm f/3.5  
✗ Zoom-Nikkor 43-86mm f/3.5  
✗ Zoom-Nikkor 80-200mm f/4.5  
✗ Zoom-Nikkor 50-300mm f/4.5 ED  
✗ Zoom-Nikkor 50-300mm f/4.5 (Fisheye)  
✗ Fisheye-Nikkor 6mm f/2.8  
✗ Fisheye-Nikkor 8mm f/2.8  
✗ Fisheye-Nikkor 16mm f/3.5 (Special)  
PC-Nikkor 28mm f/4  
PC-Nikkor 35mm f/2.8  
✗ Noct-Nikkor 58mm f/1.2  
✗ Micro-Nikkor 55mm f/3.5  
✗ Micro-Nikkor 105mm f/4  
✗ Micro-Nikkor 200mm f/4 IF (Teleconverter)  
Nikon Teleconverter TC-14  
Nikon Teleconverter TC-200  
Nikon Teleconverter TC-300

### Notes:

1) When using PC-Nikkor lenses, it is important to note that exposure metering must be performed before the lens is shifted; should metering be performed after shifting, it may result in erroneous metering indication. First, note the shutter speed needle's position inside the viewfinder before shifting the lens. After shifting the lens, reset the ASA film speed scale (2) until the same shutter speed appears inside the viewfinder. For details, refer to the instruction manual of the lens.

2) Older Nikkor lenses which have been modified for AI operation and AI lenses of other than Nikon manufacture do not provide full performance with the Nikon EM, when used with the SB-E.

Nor can most AI-modified 55mm f/1.2 and 28mm f/3.5 lenses be mounted on the Nikon EM; therefore, to prevent damage, don't attempt it.

3) If you mount the EM on a tripod with a large head, contact between the lens barrel and the head may make it impossible to operate the lens. In this case, use Nikon's special adapter between the camera body and the tripod head.

Caution: Auto Nikkor lenses and lenses of other manufacture which do not have the AI feature must not be mounted on the EM. Attempts to mount such lenses will damage the camera's AI indexing mechanism.

## IX. TIPS ON CAMERA CARE

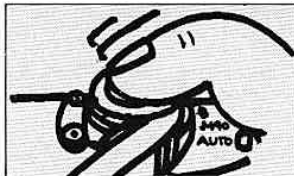

• Don't force your camera's controls—they are designed to work with a minimum of pressure.



• Clean all lens and prism surfaces periodically with a blower-type brush or lens tissue moistened with an approved photo lens cleaning liquid.

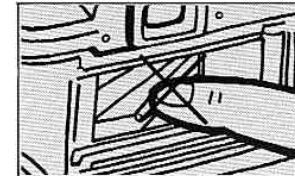

• Avoid touching the camera's interior surfaces, especially the shutter curtains (16) and film pressure plate (39).



• If you drop the camera accidentally, take it to a Nikon authorized dealer or service center for immediate servicing.



• Store your camera, lenses, accessories in a cool, dry place. Remove the batteries when the camera or accessories are not to be used for an extended period.



• Dispose of used batteries properly—never throw them into fire. For battery performance by brand, refer to manufacturer's literature.

## X. SPECIFICATIONS

ype of camera 35mm single-lens reflex (SLR), aperture-priority automatic  
icture format 35mm (24mm x 36mm film size)  
ens mount Nikon bayonet type  
enses usable Nikon Series E 50mm f/1.8 as Standard; other Series E lenses; AI-type Nikkor lenses and others (p. 30)  
hutter Electronically controlled, vertical-travel, metal focal-plane shutter; stepless speeds from 1 sec. to 1/1000 sec. when shutter operation mode selector is set to **AUTO**; 1/90 sec. mechanical shutter speed when set to **M90; B** setting also provided for long exposures  
ilm advance Film winding lever provided; completed stroke of 144° simultaneously advances film, cocks shutter and operates frame counter; choice of one continuous stroke or series of shorter strokes  
iewfinder Fixed eyelevel pentaprism full-aperture viewing type with built-in TTL exposure meter; shutter speed scale and exposure needle visible inside; ready-light lights up when SB-E or SB-10

### Focusing screen

### Reflex mirror Self-timer

### Exposure measurement

### Metering range

### Exposure signal

Speedlight is in use; center of scale's bracket indicates 1/90 sec.; finder coverage approx. 92% of picture field; 0.86X magnification with 50mm lens set at infinity (∞)

Fixed-type Nikon "K" screen; comprises matte fresnel field with central split-image range-finder spot surrounded by micro-prism ring and 12mm-dia. reference circle which denotes area of center-weighted metering  
Instant-return, non-lockable type  
Lever provided can be set for up to approx. 10-sec. exposure delay; setting cancellable before shutter release button is pressed  
TTL center-weighted exposure metering at full aperture; meter incorporates one silicon photodiode (SPD)

EV 2 to EV 18 (i.e., f/2 at 1 sec. to f/16 at 1/1000 sec. at ASA 100 and with 50mm f/1.8 lens)

"Beep-beep" warning sound activated when shutter release button is pressed to fingerguard position if matching shutter



Exposure compensation

speed for lens aperture set is approx. 1/30sec. and below, or approx. 1/1000sec. and above. Approx. + 2EV when exposure compensation button is kept depressed as shutter release button is pressed

Meter power source

Two 1.5V silver-oxide batteries (S-76 type)

Meter ON/OFF switch

Meter switched on when shutter release button is pressed; stays switched on for several seconds after finger is lifted off button

Battery power checker

LED lamp lights up to indicate sufficient power availability when power check button is pressed

Film speed range

ASA25~1600

Frame counter

Shows number of frames exposed; automatically resets to "S" when camera back is opened; automatic operation starts from frame 1

Film rewind

Manual; film rewind crank rotated after film rewind button is depressed

Flash synchronization

Built-in ISO-type hot-shoe; automatic flash sync at 1/90 sec. with SB-E Speedlight Unit which activates camera's ready-light when flash operation is ready; ready-light "blinks" to signal incorrect ASA/aperture combination; M90 shutter operation mode selector setting used with other electronic flash units, providing flash sync at 1/90sec.; bulb-type units not usable

Motor drive coupling

Electrical contact and coupler built-in for operation with MD-E Motor Drive

Camera back

Swings open when film rewind knob is pulled up; memo holder provided

Body finish

Black

Accessories provided

Camera body cap, triangular grommets for neckstrap and two 1.5V silver-oxide batteries

Dimensions

135mm(W)x86mm(H)x54mm(D)

Weight

460g (body only)

• All specifications are subject to change without notice.

