

Online Mixture and Connection of Basic Motions for Humanoid Walking Control by Footprint Specification

Koichi NISHIWAKI*, Tomomichi SUGIHARA, Satoshi KAGAMI,
Masayuki INABA, and Hirochik INOUE

Department of Mechano-Informatics,
The University of Tokyo
7-3-1 Hongo, Bunkyo-ku, Tokyo, 113-8656, Japan
*nishi@jsk.t.u-tokyo.ac.jp

ABSTRACT

This paper introduces and describes a novel method which enables the online generation of humanoid walking patterns that follow desired footprint locations. Online generation is realized by the dynamically stable mixture and connection of pre-designed motions. Characteristics of ZMP are utilized in order to maintain the overall dynamic stability of “mixed” motions. Experiments using an online pattern generation software system and online walking control joystick interface for the humanoid robot H6 are introduced to show the validity of the method.

1 Introduction

Humanoid robots having a size, shape, and DOF arrangement similar to human beings are considered to have the advantage of being capable of tasks such as handling tools and moving around in spaces designed for real humans.

The first humanoid robot in the world, WABOT-1 (Waseda roBOT 1), was developed in 1973 by Kato [1]. Many other humanoid robots have subsequently been developed, and dynamic walking was realized with some of them [2, 3, 4].

Biped humanoids have a more complicated dynamics model than biped walking robots that are developed primarily to verify walking theories. Because of the high cost of calculating the dynamics, walking on biped humanoids has been realized by constructing a dynamically-stable trajectory in advance, and executing it [2, 3, 4].

The goal of humanoid walking is however to allow a variable control strategy that allows the robot to adapt its motion to a changing environment. Thus, the ability to generate a desired walking pattern according to online controls by a human or from sensory information such as visual feedback is indispensable.

In this paper, we introduce a real-time walking pattern generation method that enables a humanoid robot to follow specified footprint locations online. ZMP is adopted as the criteria for dynamic stability. The characteristics of ZMP are utilized for both the construction of typical walking trajectories in advance and the real-time generation of dynamically-stable trajectories. Experiments controlling a walking humanoid using a

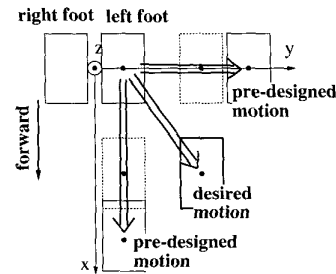

Figure 1: Mixture of Motions

joystick interface were conducted to demonstrate the validity and capability of this method.

2 Online Walking Pattern Generation

We realized walking motions that can follow arbitrary footprints given online without turning. The time for a step is fixed. Setiawan et al. realized online walking pattern generation for forward and backward walking with a constant step width [5]. They realized the walking by connecting prepared unit walking patterns.

We realize online generation of desired walking patterns in 3 stages. The first stage is the construction of typical stepping patterns in advance. To realize walking that follows arbitrary footprints, 21 typical stepping patterns are constructed to follow the designed ZMP trajectory. The second stage is the mixture of pre-designed patterns. This mixture is carried out in two phases: 1) mixture along the same axis in the horizontal plane, and 2) mixture of motions perpendicular to each other (Figure 1). For the first mixture, approximate linearity is utilized to maintain dynamic stability. The approximate independence of ZMP from perpendicular motion components is utilized for the second mixture. The third stage is the connection of stepping motions. Each stepping motion is constructed and mixed so that the torso speed at the boundaries is determined by the positional relationship between the two feet. Therefore, considering only the positional connection of the patterns, the boundary velocity of two stepping patterns also becomes the same.

We also prepared turning walking pattern segments that can be connected to the patterns described above

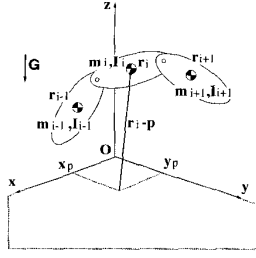

Figure 2: Coordinates for Calculating ZMP

in order to realize turning motions without stopping.

3 Dynamics Model of Humanoid for ZMP Criteria

Zero Moment Point (ZMP) was proposed by Vukobratovic[6] and it is often used as the criterion for dynamic stability for biped walking robots. If the ZMP is inside the convex hull of the contact points between a robot and the ground, the robot will not fall. Therefore motions in which the trajectory of the ZMP stays inside of the convex hull of contact points can be realized without the robot falling.

Let \mathbf{r}_i , m_i , and \mathbf{I}_i respectively represent the position, mass, and inertia tensor of the i -th link in the coordinates shown in Figure 2. The equation of motion concerning the rotation around the point $\mathbf{p} = (x_p, y_p, 0)^T$ is:

$$\sum_{i=0}^n \{m_i(\mathbf{r}_i - \mathbf{p}) \times \ddot{\mathbf{r}}_i + \mathbf{I}_i \cdot \dot{\boldsymbol{\omega}}_i\} = \sum_{i=0}^n m_i(\mathbf{r}_i - \mathbf{p}) \times \mathbf{G} + \mathbf{T}, \quad (1)$$

where \mathbf{G} and \mathbf{T} represent the acceleration of gravity and the torque caused by the ground respectively.

The ZMP is the point where the x-component and y-component of \mathbf{T} are 0. Therefore the equation to derive ZMP from the position and the acceleration of the links can be obtained as:

$$\begin{cases} x_p = \frac{\sum m_i z_i \ddot{x}_i - \sum \{m_i(\ddot{z}_i + g)x_i + (0, 1, 0)^T \mathbf{I}_i \dot{\boldsymbol{\omega}}_i\}}{-\sum m_i(\ddot{z}_i + g)} \\ y_p = \frac{\sum m_i(\ddot{z}_i + g)y_i - \sum \{m_i z_i \ddot{y}_i + (1, 0, 0)^T \mathbf{I}_i \dot{\boldsymbol{\omega}}_i\}}{\sum m_i(\ddot{z}_i + g)} \end{cases}, \quad (2)$$

where $\mathbf{G} = (0, 0, -g)^T$, $\mathbf{r}_i = (x_i, y_i, z_i)^T$.

According to Eq.(2), the x-component of the ZMP (x_p) is independent of the motion along the y-axis. Similarly the y-component of the ZMP (y_p) is independent of the motion along the x-axis. This characteristic is utilized for the mixture of motions at a right angle.

The x-component of the ZMP (x_p) can be regarded as a linear combination of x and \ddot{x} . (The same applies to the y-component of the ZMP.) This characteristic is utilized for the mixture of the motions along the same axis.

4 Offline Construction of Typical P patterns

4.1 Fast Generation Method of Motion Trajectories

We previously proposed a fast generation method of humanoid motion trajectories that follow desired ZMP trajectories [7]. For the construction of typical patterns of walking segments, we extended this method to arbitrary velocity boundary conditions.

4.2 Construction of Typical P patterns for Mixture

Typical patterns are constructed satisfying the following conditions:

- Patterns are designed using the trajectories of the position of the upper body and both feet.
- Three groups of patterns are constructed: 1) initial steps (starting from rest), 2) normal steps (continuous walking), and 3) final steps (coming to a stop).
- Motions in the x-z plane and motions in the y-z plane are separately constructed for each group.
- Vertical and rotational components of each motion is constructed to be identical among the same group of trajectories.
- Motion time for a step is the same in each group.

The mixture is carried out using the pre-designed motions in each group.

The position and velocity of the upper body at the boundary time is designed to follow the equations below in order to guarantee that the position and velocity become the same at the boundary between two connected mixed patterns.

$$x_t(t_b) = \frac{x_l(t_b) + x_r(t_b)}{2} + x_T, \quad (3)$$

$$y_t(t_b) = \frac{y_l(t_b) + y_r(t_b)}{2}, \quad (4)$$

$$|\dot{x}_t(t_b)| = K_x |x_l(t_b) - x_r(t_b)|, \quad (5)$$

$$|\dot{y}_t(t_b)| = K_y |y_l(t_b) - y_r(t_b)| + V_y, \quad (6)$$

where $x_l(t)$, $y_l(t)$, $x_r(t)$, $y_r(t)$, x_T , y_T represents the trajectory of the upper body and both feet, and t_b represents the boundary time.

5 Real-time Generation Method of Desired Walking Patterns

The real-time mixture of motions that maintains overall dynamic stability is realized in two phases. First, the motions along the same axis are mixed, and then the motions at a right angle.

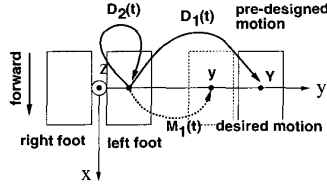

Figure 3: The Same Axis Mixture (Sideward)

5.1 Mixture of Motions along the Same Axis

As mentioned in section 3, the x-component t of the ZMP is expressed as a linear combination of x and \ddot{x} . Let $\mathbf{A}(t)$ and $\mathbf{B}(t)$ each represent the trajectories of the torso and feet for stepping motions. Then a new stepping motion $\mathbf{C}(t)$ is constructed as:

$$\mathbf{C}(t) = k_1 \mathbf{A}(t) + k_2 \mathbf{B}(t), \quad (7)$$

where $k_1 + k_2 = 1$.

Taking some conditions into consideration, such as:

- linearity of the differential,
- no redundancy between each foot and torso, (There are 6 DOF for each leg.)
- the motion component along the z-axis and the rotational component of the motion are the same in $\mathbf{A}(t)$ and $\mathbf{B}(t)$,

the trajectory of the ZMP for the motion $\mathbf{C}(t)$ is approximately represented as:

$$\text{ZMP}_C = k_1 \text{ZMP}_A + k_2 \text{ZMP}_B, \quad (8)$$

where ZMP_A and ZMP_B are the trajectories of the ZMP for motions $\mathbf{A}(t)$ and $\mathbf{B}(t)$ respectively.

Consequently, the new motion can be generated by the linear combination of trajectories of pre-designed motions. This motion will be dynamically stable if the mixture is carried out such that the same linear combination of ZMP becomes the desired trajectory of the mixed motion as described below for some cases.

Since this mixture is a linear combination of pre-designed typical motions, the mixed motion also satisfies the equation (3), (4), (5), (6) that describes the upper body position and velocity at the boundary time. When connecting two mixed motions, by just considering the continuity of the feet position, the continuity of the upper body position and velocity is achieved at the same time.

Generation of Sideward Step A stepping motion of y [mm] to a side (Figure 3) can be generated from 2 typical motions. $\mathbf{D}_1(t)$ is the trajectory of a pre-designed stepping motion to a point Y [mm] to one side. $\mathbf{D}_2(t)$ is the trajectory of a pre-designed stepping motion "in place" (no sideward motion). Let

$$\mathbf{M}_1(t) = \frac{y}{Y} \mathbf{D}_1(t) + \frac{Y-y}{Y} \mathbf{D}_2(t). \quad (9)$$

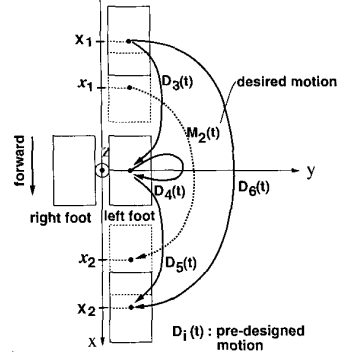

Figure 4: the Same Axis Mixture (Forward)

$\mathbf{M}_1(t)$ is the trajectory of a stepping motion to a point y [mm] to one side. The trajectory of the ZMP for $\mathbf{M}_1(t)$ is expressed by:

$$\text{ZMP}_{M_1} = \frac{y}{Y} \text{ZMP}_{D_1} + \frac{Y-y}{Y} \text{ZMP}_{D_2}. \quad (10)$$

Here the linear combination of the desired ZMP trajectories of the pre-designed motions with the same ratio as the mixture of the motions becomes the desired ZMP trajectory of the mixed motion. Therefore the motion generated with this method of mixture becomes dynamically stable.

Generation of Forward Step A forward stepping motion of the left foot from x_1 [mm] behind to x_2 [mm] forward relative to the right foot can be generated by the mixture of 4 typical motions (Figure 4). $\mathbf{D}_3(t)$, $\mathbf{D}_4(t)$, $\mathbf{D}_5(t)$, and $\mathbf{D}_6(t)$ are trajectories of pre-designed motions shown as Figure 4. (\mathbf{D}_2 and \mathbf{D}_4 are not the same: \mathbf{D}_2 is not concerned with the motion along x-axis, and \mathbf{D}_4 is not concerned with the motion along y-axis.) Let

$$\begin{aligned} \mathbf{M}_2(t) = & \frac{x_1(X_2 - x_2)}{X_1 X_2} \mathbf{D}_3(t) \\ & + \frac{(X_1 - x_1)(X_2 - x_2)}{X_1 X_2} \mathbf{D}_4(t) \\ & + \frac{(X_1 - x_1)x_2}{X_1 X_2} \mathbf{D}_5(t) + \frac{x_1 x_2}{X_1 X_2} \mathbf{D}_6(t) \end{aligned} \quad (11)$$

$\mathbf{M}_2(t)$ is a trajectory of the stepping motion from x_1 [mm] behind to x_2 [mm] forward. The motion generated with this method becomes dynamically stable as in the first example.

In order to confirm the validity of this mixture method, stepping motions from 60[mm] behind to 90[mm] forward were generated and the ZMP trajectories of mixed motions were calculated in a simulation environment. (Here X_1 is -180[mm], and X_2 is 180[mm].) The average error of the ZMP trajectory

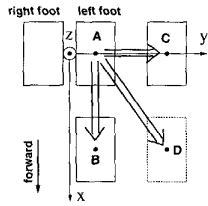

Figure 5: Mixture of P erpendicular Motions

from the desired one is 0.6[mm]. Considering that the typical motions are constructed so that the average ZMP error is less than 1.0[mm], the error after the mixture is small enough.

5.2 Mixture of Motions at a Right Angle

A motion in the x-z plane and a motion in the y-z plane can be mixed if the z-axis and rotational components of two motions are the same. As mentioned in section 3, the ZMP along x-axis is independent of the motion component along the y-axis and vice versa. Consequently, the x-component of the ZMP trajectory for the mixed motion is approximately the same as the ZMP trajectory for the motion in the x-z plane used for the mixture. The same applies to the y-component of the ZMP trajectory. Figure 5 shows an example of this mixture. Let motion M_1 be dynamically stable stepping motion in the x-z plane from point A to point B, and let M_2 be a dynamically stable stepping motion in the y-z plane from A to C. The stepping motion from A to D can be generated with a mixture of M_1 and M_2 .

To confirm the validity of this technique, a mixture of forward motion and sideward motion was carried out, and the ZMP trajectory of the mixed motion was calculated in a simulation environment. In this case, the forward motion ranged from 60[mm] backward to 90[mm] forward, and the sideward motion ranged from the neutral position to 100[mm] to one side. The average ZMP error of the mixed motion was 0.4[mm]. It is small enough considering that typical motions are constructed so that the ZMP errors are less than 1.0[mm].

6 Experiments

6.1 Humanoid Robot H6

The Humanoid H6 [8] is used for the experiment. It is 1361[mm] in height, and weighs 55[kg]. The distance between the hip joint and the ankle joint is 500[mm]. It has a total of 35 DOFs. Each leg has 7 DOFs including a 1-DOF toe joint, each arm has 7 DOFs with a 1-DOF gripper, and the head has 4 DOFs. It has an onboard PC and batteries inside the torso.

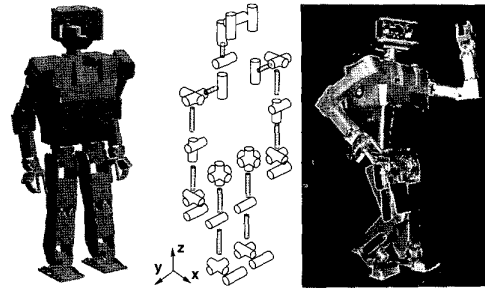

Figure 6: Left: Geometric Model in Euslisp, Center: DOF arrangement, Right: Photo of H6

	start	normal	stop
fwd & bwd	3	7	3
sideward	2	4	2

Table 1: Number of Typical Motions

6.2 Construction of T ypical Motions

Considering the symmetry of the robot, only the stepping motions for the left foot were prepared. 21 patterns in total (Table 1) were prepared in order to realize arbitrary footstep locations (except for turning while walking).

In order to realize turning walking continuously with a normal walk, we also prepared turning walk segments. It is difficult to realize a turning step of an arbitrary angle rotation by the mixture method. Thus, turning walks for discrete angles are realized. Four types of turning walks were prepared, 10 degrees per step turn in forward walking, 20 degrees turn in forward walking, and 10 and 20 degrees turn in backward walking.

Three groups of patterns were prepared for each type of turning walk: 1) start of turning motion, 2) regular turning (continuous motion), and 3) end of turning.

For start of turning, eight patterns were prepared, four for the inner foot step, and four for the outer foot. Four patterns for the inner foot step are shown in Figure 7. Start of turning step from the position in hatched area in Figure 7 can be generated by the mixture of these four patterns. Then the generated pattern can be connected to the corresponding normal patterns. For regular turning two patterns were prepared: inner foot step, and outer foot step. Finally, eight patterns were prepared for the end of turning in the same way as the start of turning.

6.3 Control Software

We implemented a software system for realizing online control of the walking motion and additional modules for interfacing a joystick controller as shown in Figure 8. RT-Linux[9] V2.2 was used as the real-time

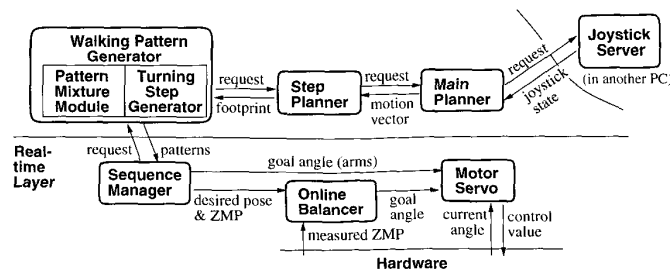

Figure 8: Control Flow for Online Generation and Joystick Experiment

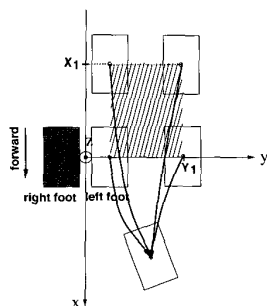

Figure 7: Typical Patterns for Start of Turning

operating system. The function of each module is described below.

Motor Servo is a software PD servo module. It runs at 1[ms.] cycle.

Online Balancer is a sensor feedback module that stabilizes the walking. The ZMP position is measured using force sensors distributed at the feet. In order to reduce the error from the desired ZMP, the horizontal position of the torso is adjusted. Then the desired leg angles are calculated using inverse kinematics. It runs at 1[ms.] cycle.

Sequence Manager stores motion patterns and outputs poses by interpolating them. It can execute patterns continuously when successive patterns are designated. It also has the ability to notify other modules when the execution time reaches specified values. For online generation of walking, this function is used as the signal to request the next step pattern. The notification time is set to 100 [ms.] before execution of the current walking pattern segment ends.

Walking Pattern Generator is the implementation of the method described in this paper. It generates one step of walking that follows a commanded footprint location. In order to avoid making the robot fall down when the control stops, it outputs successive motion patterns that forces

the robot to stop at the same time. It took about 3.8[μs] to generate 1[s] stepping pattern.

Step Planner is the module that decides the desired footprint from the input vector. The input is the combination of a two dimensional vector that represents the direction and magnitude of motion in the horizontal plane, and a value that represents the turning rotation.

Main Planner is the controller for the joystick interface experiment. It queries the joystick server which runs on another pc for the current status of the joystick, and calculates the direction and magnitude of the horizontal motion and the rotation angle.

6.4 Joystick Control Interface Experiments

Experiments controlling the robot walking by a joystick were performed to show the capability of the online pattern generation method. The direction, step width and rotation angle of walking were commanded by using a 3 DOF joystick. Then the software system described in the previous section plans the desired footprints and executes them. The maximum distance between the two feet was limited to 160[mm] for the forward direction, and 316[mm] (140[mm] away from the neutral position) for the sideward direction. The time for a normal step was 1.0[sec.], and for the first and last step was 1.2[sec.]. Several snapshots taken during the experiments are shown in Figure 9.

7 Conclusion

A real-time walking pattern generation method was introduced. In order to generate the desired walking pattern without complicated dynamics calculations or lengthy iterative calculations, the linearity and independence characteristics of the ZMP from the robot motion is utilized. Consequently, dynamically stable walking patterns that follow desired footprint locations can be generated online using just a mixture of a pre-designed motions. (21 pre-designed motions were prepared for the experiment described above to realize the stepping motion between arbitrary positions without rotation.)



Figure 9: Experiment of Walking Controlled by Joystick. (Avoiding Obstacles)

An online walking control system was constructed, and an online walking control experiment using a joystick demonstrated the capability of the method.

Adapting the walk in reaction to changes in the environment by utilizing sensory information, especially vision, is the next research topic which is currently under investigation.

This work is supported by the Japan Society for the Promotion of Science Grant for Research For The Future JSPS-RFTF96P00801.

REFERENCES

- [1] Ichiro Kato. Development of wabot-1. *Biomechanism 2, The University of Tokyo Press*, pages 173-214, 1973.
- [2] Kazuo Hirai. Current and future perspective of Honda humanoid robot. In *In Proceeding of 1997 IEEE/RSJ International Conference on Intelligent Robots and Systems (IROS'97)*, pages 500-508, 1997.
- [3] Jin'ichi Yamaguchi, Sadatoshi Inoue, Daisuke Nishino, and Atsuo Takanishi. Development of a bipedal humanoid robot having antagonistic driven joints and three dof trunk. In *Proc. of the 1998 IEEE/RSJ Int. Conf. on Intelligent Robots and Systems*, pages 96-101, 1998.
- [4] Ken'ichiro Nagasaka, Masayuki Inaba, and Hirochika Inoue. Walking pattern generation for a humanoid robot based on optimal gradient method. In *Proc. of 1999 IEEE Int. Conf. on Systems, Man, and Cybernetics*, 1999.
- [5] Samuel Agus SETIAWAN, Sang Ho HYON, Jin'ichi Yamaguchi, and A. Takanishi. Physical interaction between human and a bipedal humanoid robot -realization of human-follow walking-. In *Proceedings of the IEEE International Conference on Robotics & Automation*, pages 361-367, 1999.
- [6] D.Juricic M.Vukobratovic, A.A.Frank. On the stability of biped locomotion. In *IEEE T. on Biomed. Engg. BME-17*, number 1, pages 25-36, 1970.
- [7] Satoshi Kagami, Koichi Nishiwaki, Tomonobu Kitagawa, Tomomichi Sugihara, Masayuki Inaba, and Hirochika Inoue. A fast generation method of a dynamically stable humanoid robot trajectory with enhanced zmp constraint. In *Proceedings of IEEE International Conference on Humanoid Robotics*, 2000.
- [8] K. Nishiwaki, T. Sugihara, S. Kagami, F. Kanehiro, M. Inaba, and H. Inoue. Design and development of research platform for perception-action integration in humanoid robot : H6. In *Proceedings of the 2000 IEEE/RSJ International Conference on Intelligent Robotics and Systems (IROS 2000)*, pages 1559-1564, November 2000.
- [9] Michael Barabanov. A linux-based real-time operating system. Master's thesis, New Mexico Institute of Mining and Technology, 1997.