

2004 7 20 ()

- 가

1.

?

2.

3.

4.

5.

6.

?

▪ :

)

(

▪ (16) : 8 (, , , , 6가 , ,) , , PCB , , (• , BTEX, TPH), TCE, PCE

-
-
-
-
-

/

가



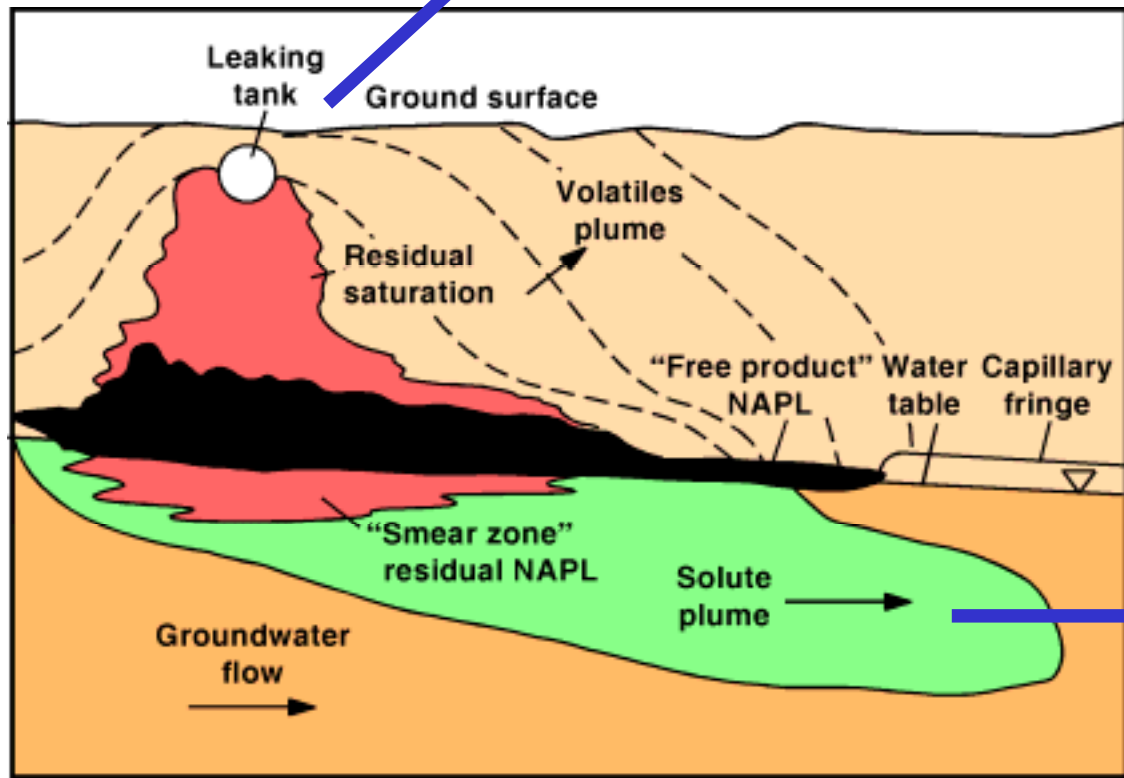

오염원	오염요인	예상오염물질
석유류 제조 및 저장시설	저장탱크 배관 부식, 누출사고	- BTEX, TPH, PAHs, PCP 등
유독물질 저장시설	저장탱크 배관 부식, 누출사고	- VOC, PAHs 등
산업지역	저장탱크 배관 부식, 누출사고	- 유류 - 유기용제 (TCE, PCE, 1,1,1-TCE 등) - 석유화학 원료 (톨루엔, 페놀 등) - 중금속 (카드뮴, 납, 6가크롬, 비소, 수은 등)
폐기물 매립지	침출수 누출	- 유기물, 중금속, VOC 등
폐기물 소각장	배출가스 및 소각재	- 다이옥신, PAHs, - Pb, Cd 등 중금속
휴.폐광산	폐광재, 갱내수	- 폐광재 : 중금속 - 갱내수 : 중금속, 산성폐수
군부대	폐기물 매립, 유류누출, 사격장, 훈련장, 군항, 비행장 등	- BTEX, PAHs, 중금속 등

■
■

	가		가	
	1.5	12	4	30
	50	200	125	500
	6	20	15	50
	4	16	10	40
	100	400	300	1,000
6가	4	12	10	30
	10	30	-	-
PCB	-	12	-	30
	2	120	5	300
	4	20	10	50
BTEX	-	80	-	200
(TPH)	-	2,000	-	5,000
TCE	8	40	20	100
PCE	4	24	10	60

⋮

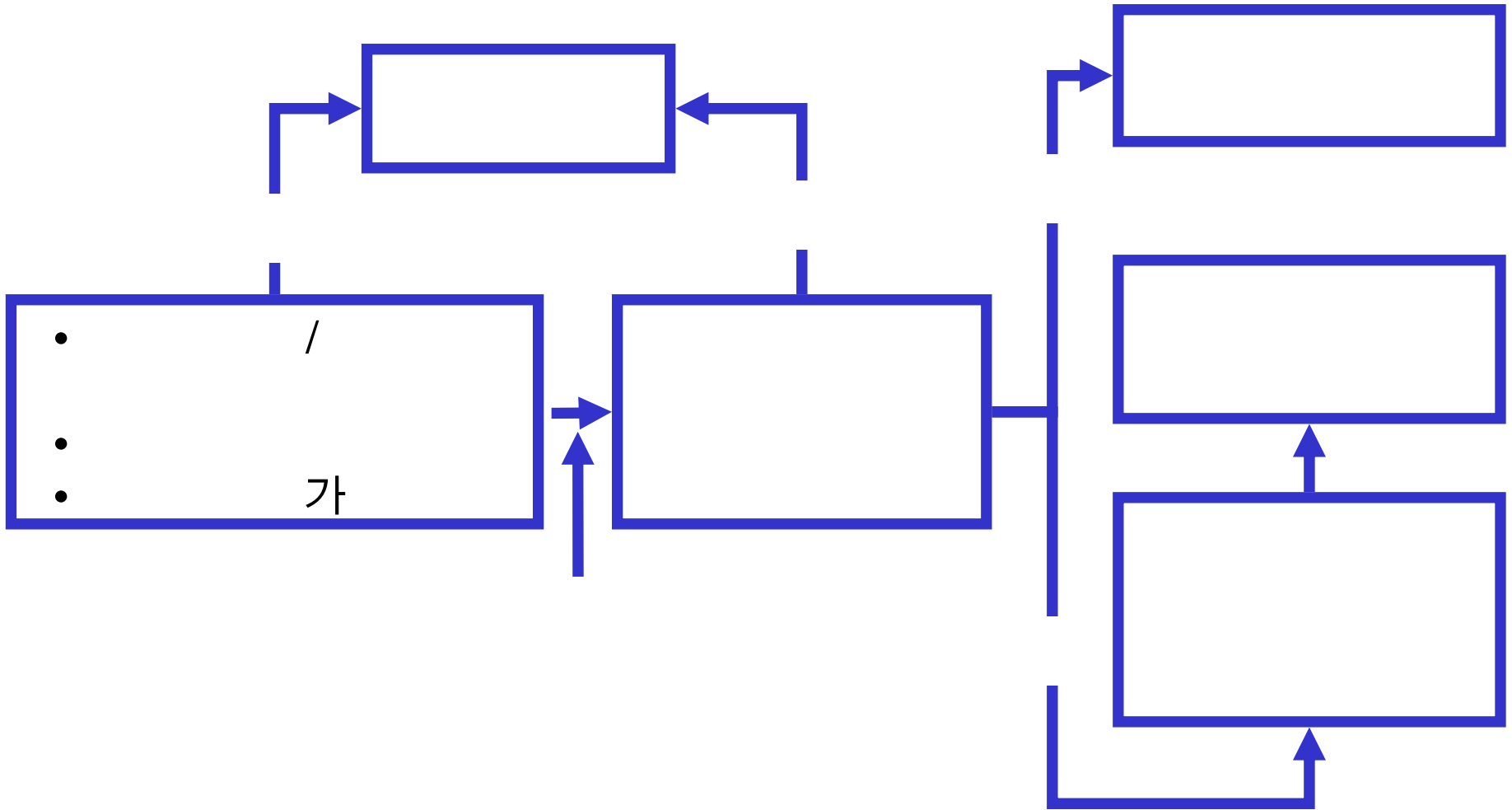

(5 , 2002)

		(m2)
	1565	54085
	263~5258	21~421
	502	22274~24968
	-	-
	>200	>108
	2432~7427	76488~79582

■

⋮

—

,

,

■

⋮

,

,

가

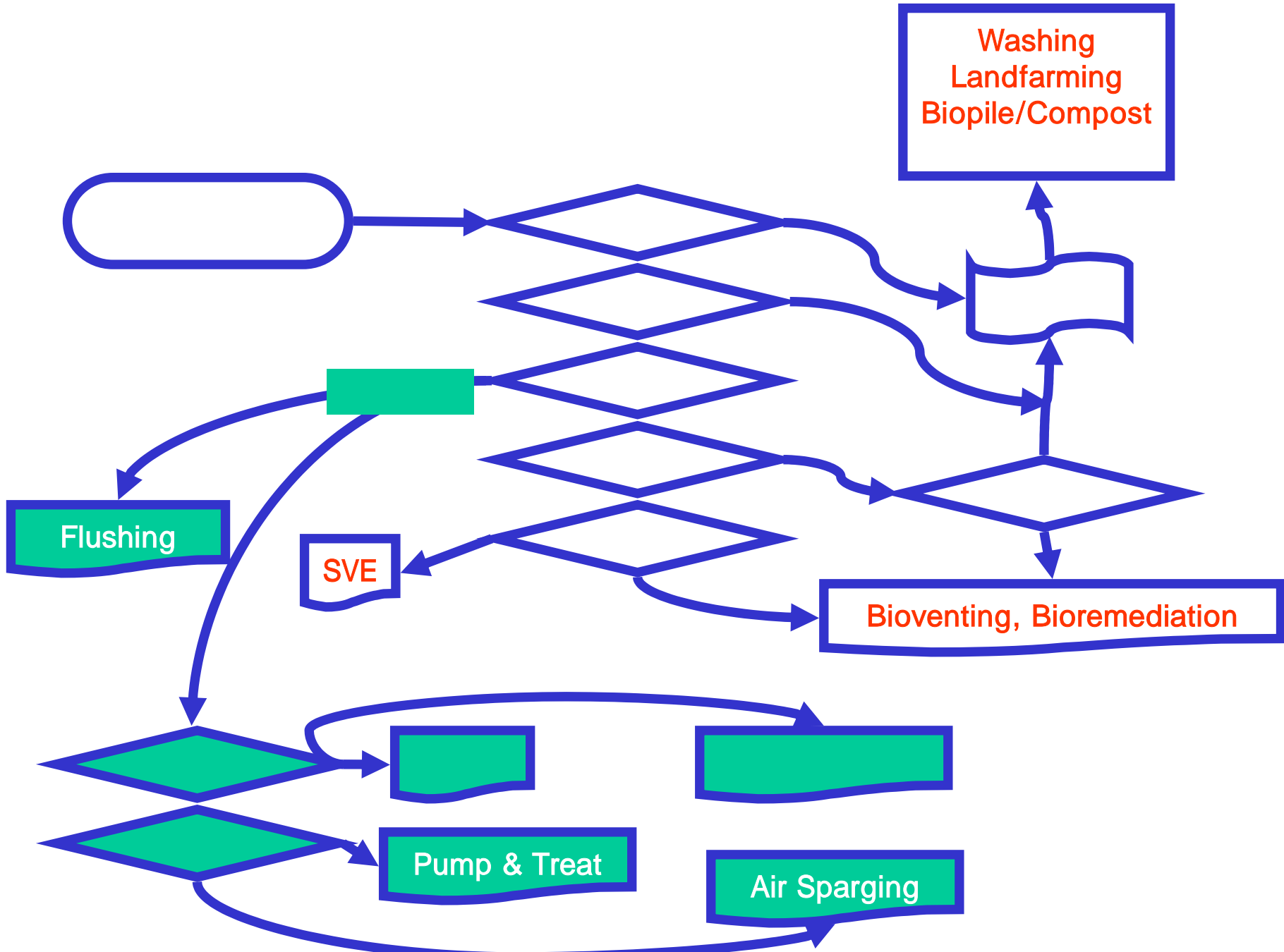

Washing
Landfarming
Biopile/Compost

Flushing

SVE

Bioventing, Bioremediation

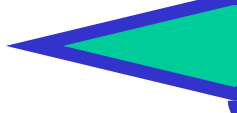
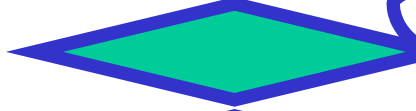

Pump & Treat

Air Sparging

⋮

- “ 2 ”
- : 106,500 m² (3 2),
- : 5m ,
- TPH & BTEX
-

-
-

- (land farming) : ,
- (thermal desorption) :
- (biopile) : ,



1. ' _____ ' : ' _____ ' ,
()

()

• ' _____ ' - 16 (_____)
223, 71, 31), :

• _____ - 가 _____ ,
: 10m

2.

•

,

—

/

,

•

4.

•

—

•

—

,

,

•

•

/

—

5.

•

/

⋮

⋮

⋮

6.

-
-
-

—

—

,

,

—

—

1) ' ' 가
가

2)

—

— 2

3)

—

7. NGO

-

-

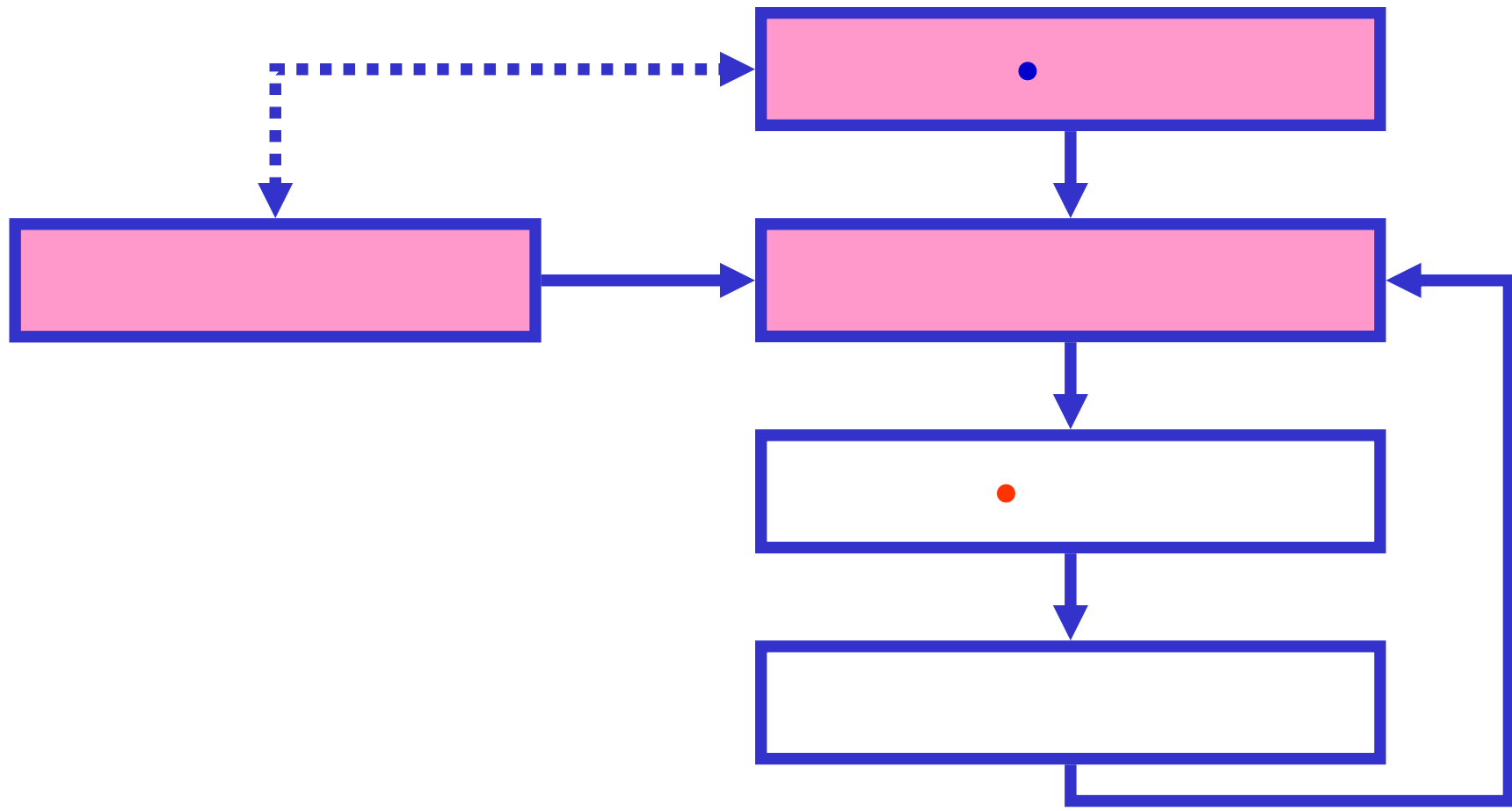



✓ 2003 2 (,)가

✓ 가 2

✓ SOFA , ,

-



✓ SOFA
case

case by

-

✓ .

/ /

✓

-



가

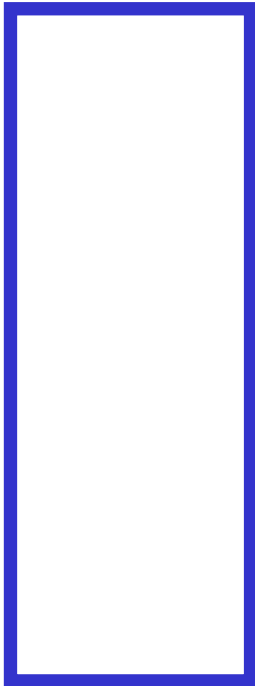

-

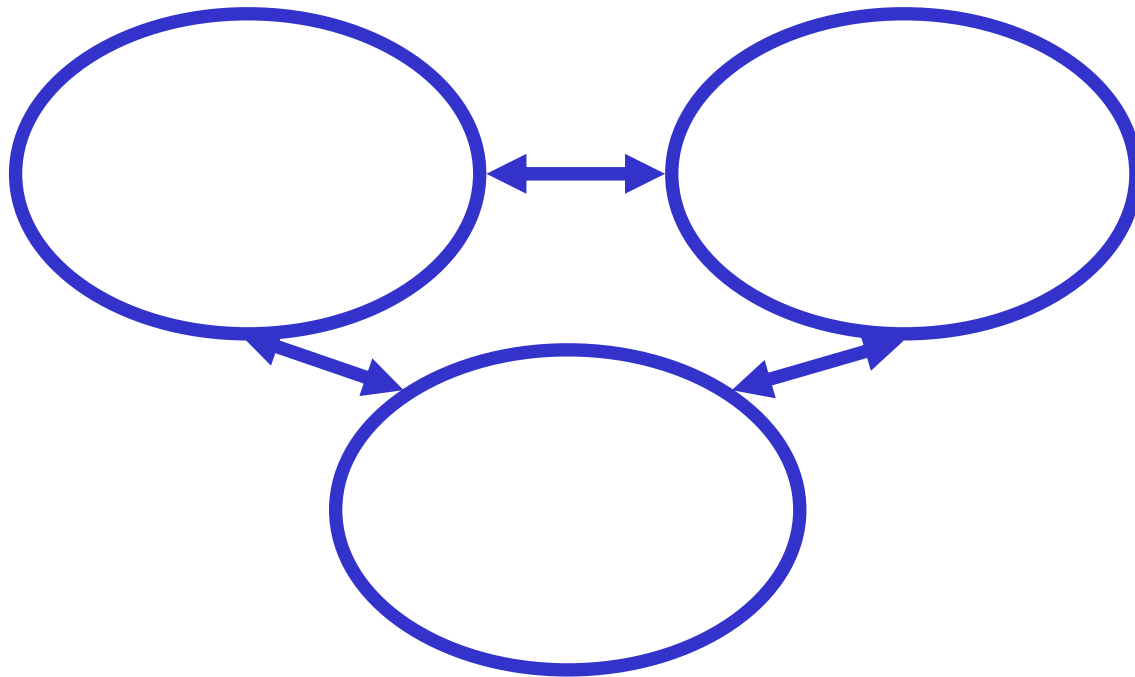



—

✓

✓

✓

✓

3

2009

.

25

—



가

가?



“

”



—



가 “

”



— /



,



DB

GIS



— /



✓

가

->

✓

,

가

->

— /



✓

✓

/

—

/



✓

/

/

case

가

,

/

.



✓

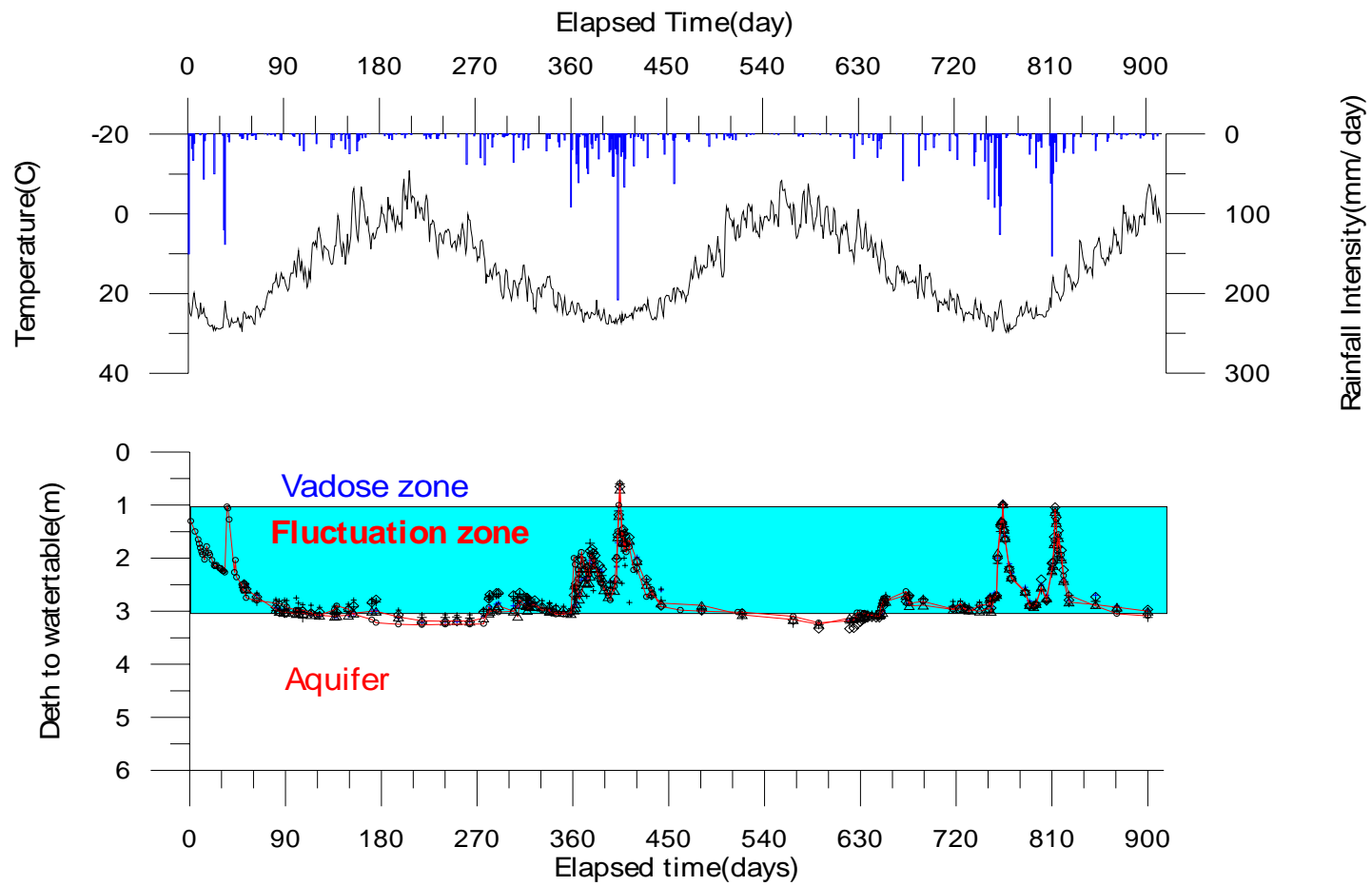

— /

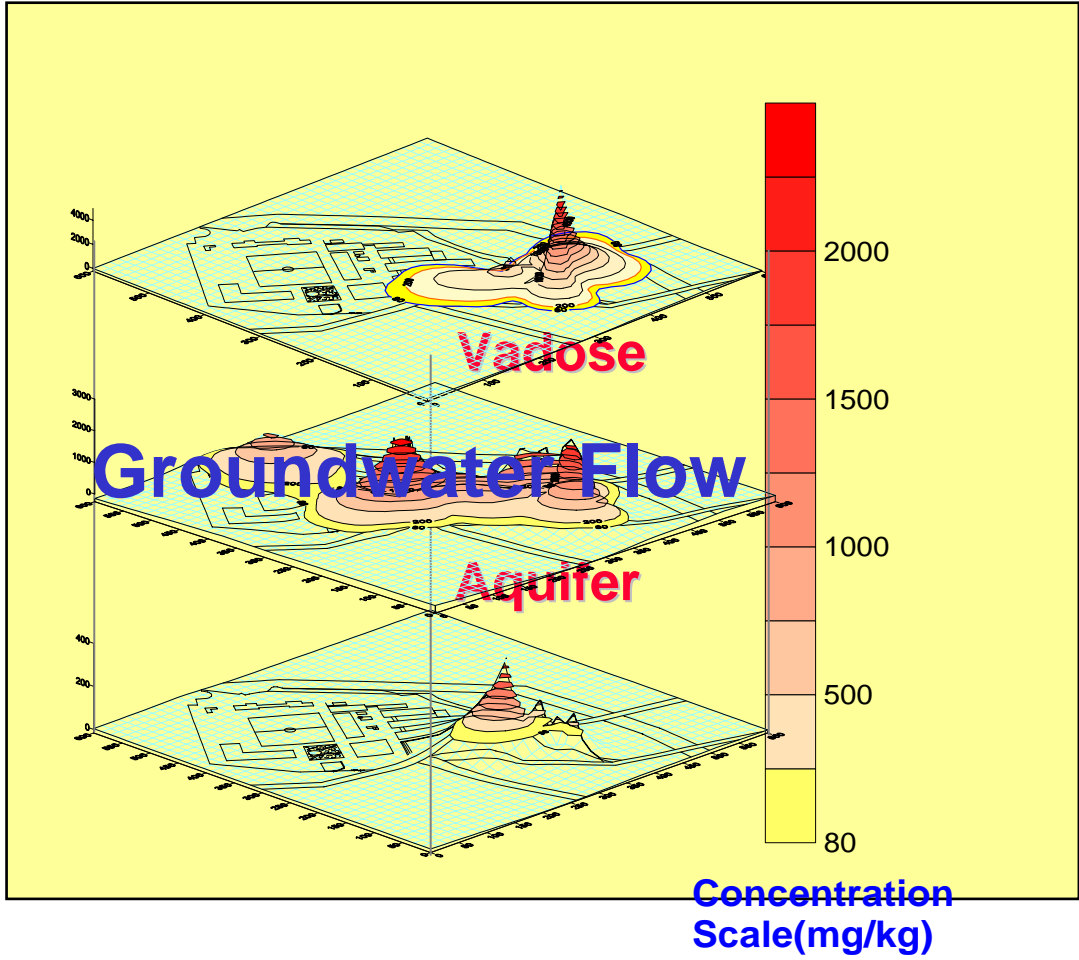

— /

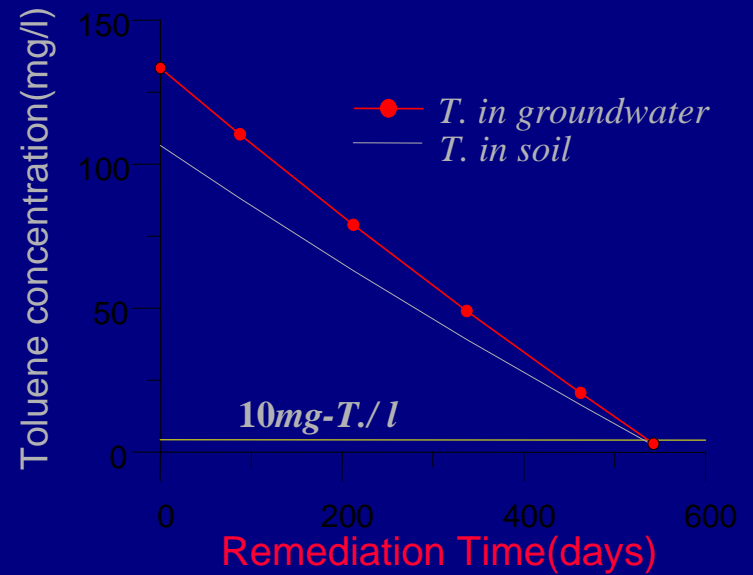
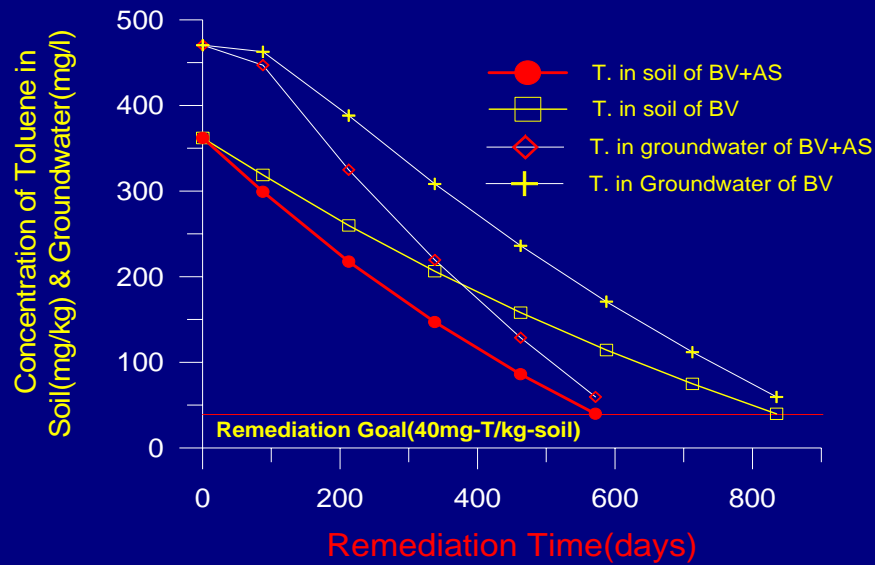

Cleanup time : 580 days

—



/



/



,

,



NGO

•

/

