

# PENTAX<sup>®</sup>

## 645

OPERATING MANUAL



## **Welcome to the Fantastic World of Pentax Multi-mode Photography with Medium Picture Format !**

The Pentax 645, our latest development in the area of the medium format SLR, promises a superior 6 x 4.5cm result with 120/220 or 70mm film. Made possible through our vast experience and technology accumulated over the years, the new multi-mode 645 camera allows accurate exposure control utilizing the full range of available modes; Programmed AE, Aperture-priority AE and Shutter-priority AE, Metered manual mode and TTL auto flash control.

The Pentax 645 is a professional camera possessing a number of highly sophisticated features; a built-in automated film wind along with digital indications of various photographic information through LCD (Liquid Crystal Display) viewed from the outside of the camera, and clearly visible LED (Light Emitting Diode) indications within the viewfinder. To obtain optimum results, it is recommended that this manual be thoroughly read and understood prior to actual use of the Pentax 645.

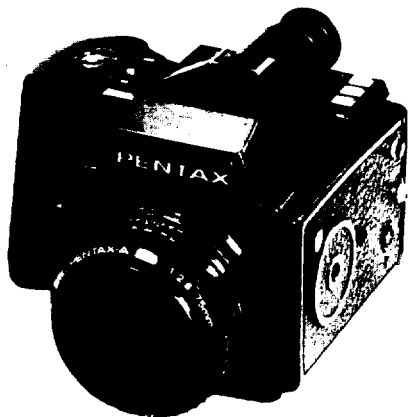

## CONTENTS

Description of parts .....	2 ~ 5	Shutter-priority AE mode .....	38 ~ 39
Inserting batteries .....	6 ~ 7	Photographic modes with the aperture set at appropriate f/stops .....	40
Attaching/removal of Grip 645 .....	8 ~ 9	Aperture-priority AE mode .....	40 ~ 41
Lens mounting/interchange .....	10 ~ 11	Metered manual mode .....	42 ~ 43
Attaching Shoulder Strap .....	12	Utilizing 60 (1/60 sec.) and B (Bulb) position ..	44 ~ 45
Film Holders 645 and attaching/detaching .....	13	Utilizing Pentax dedicated flash units .....	46 ~ 47
Shutter release without film in camera .....	14	TTL auto flash operation .....	48
Problems and remedial solutions .....	15 ~ 16	External auto flash operation .....	49
Loading/unloading .....	18 ~ 19	Dedicated flash precautions .....	50
C/S Switch, Main Switch and Shutter Release Button .....	20	Using ordinary flash units .....	51
LCD indication for exposure count .....	21	Programmed AE diagram, meter coupling and shutter/aperture coupling range .....	52 ~ 53
Operation panel and LCD Window .....	22 ~ 23	Exposure compensation .....	54 ~ 55
Film speed adjustment and Memo Holder .....	24 ~ 25	Depth-of-field .....	56 ~ 57
Viewfinder display .....	26	Depth-of-field preview .....	58
LED mode warnings in viewfinder .....	27	Multiple exposure .....	59
Eyecup 645/diopter adjustment .....	28 ~ 29	Tripod support .....	60
Focusing procedure/recommended camera holding positions .....	30 ~ 31	Infrared index mark .....	61
Switching to "A" (auto) and setting photographic mode .....	32 ~ 33	Interchanging focusing screens .....	62
Photographic mode with the aperture set at "A" (auto) .....	34	Interchangeable focusing screens .....	63
Programmed AE mode .....	34 ~ 35	Manual film wind .....	64 ~ 65
Aperture-priority AE mode .....	36 ~ 37	Maintenance .....	66 ~ 67
		Specifications .....	68 ~ 69
		Warranty policy .....	70 ~ 71

## DESCRIPTION OF PARTS

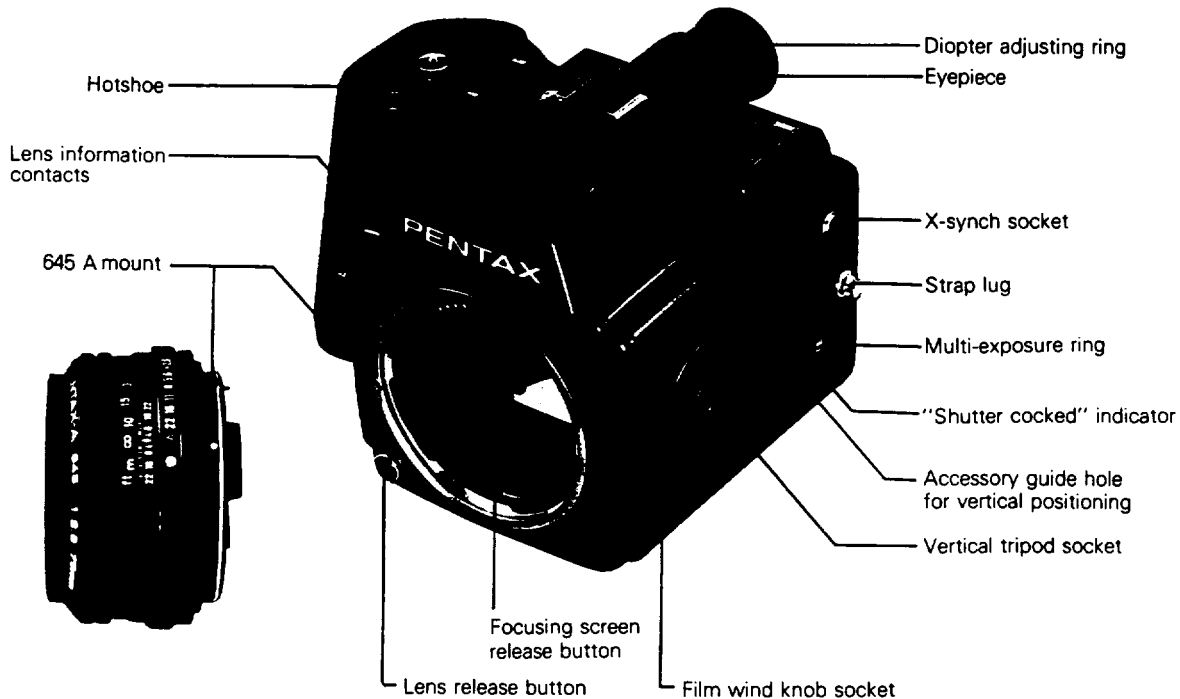

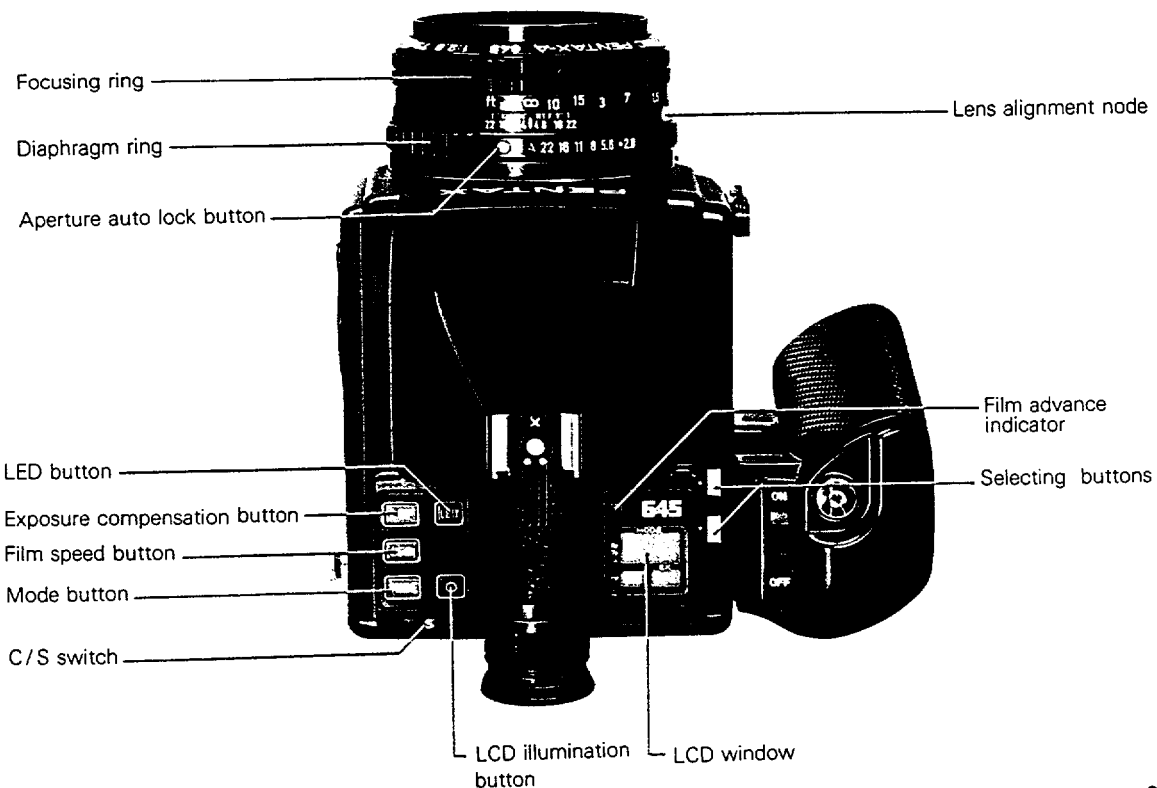

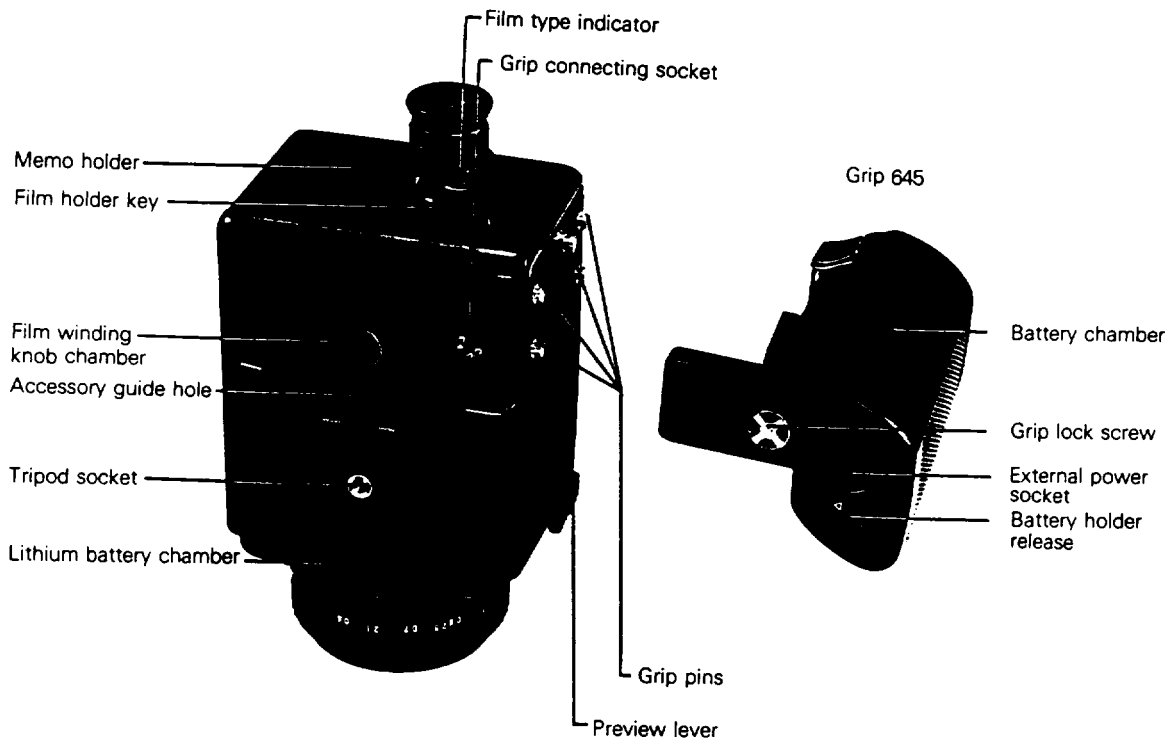

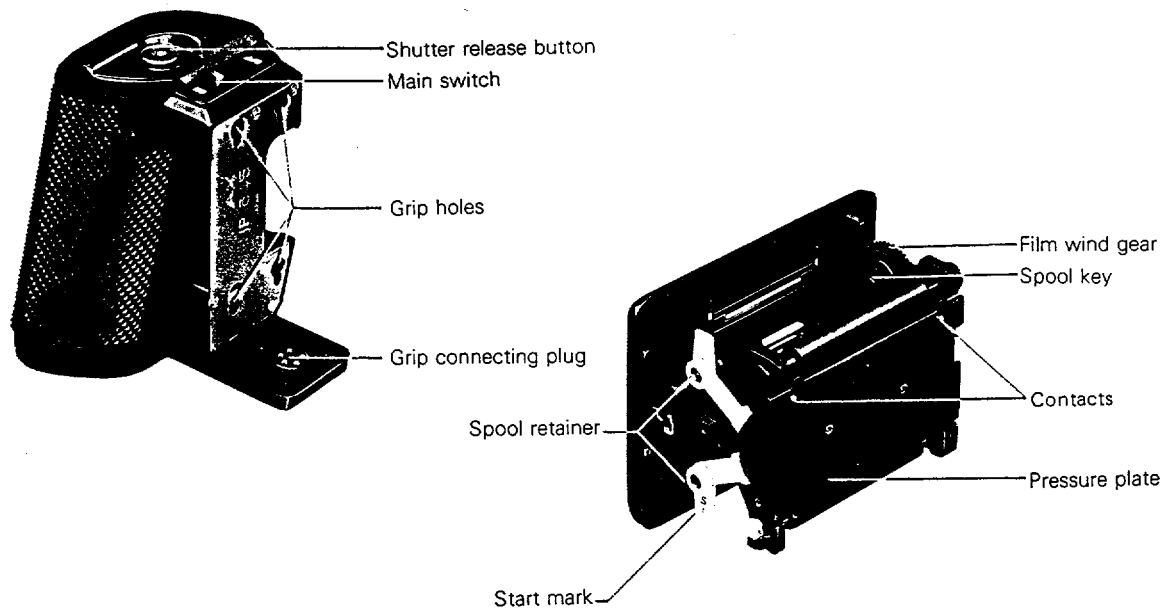

## BASIC PREPARATION

Use six AA batteries of the types mentioned below in accordance with the instructions on the battery case;

- Manganese batteries
- Alkaline batteries
- Ni-Cd rechargeable batteries (a charger needed)

(New batteries are packed at the time of shipment, but because of inherent self-discharging, performance gradually deteriorates as time goes by. In such a case, replace the packed batteries with brand-new ones.)

## INSERTING BATTERIES (GRIP 645)

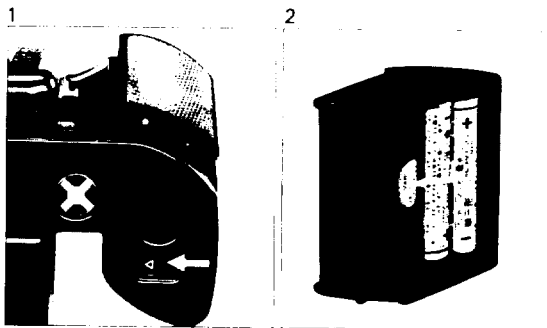

1. Prior to placing of the batteries into the grip section, turn off the main switch located on the grip. Then remove the battery holder by pushing battery holder release button in direction of the arrow.
2. Install six 1.5V "AA" batteries in accordance with the diagram located in the battery chamber. Make sure proper battery polarity (+ and -) is maintained. Angle the batteries into the holder, placing the battery onto the spring plate (contact) first, then push the other end into position. The batteries are easily removed by pressing the battery in the oval cutouts on both sides of the battery holder.



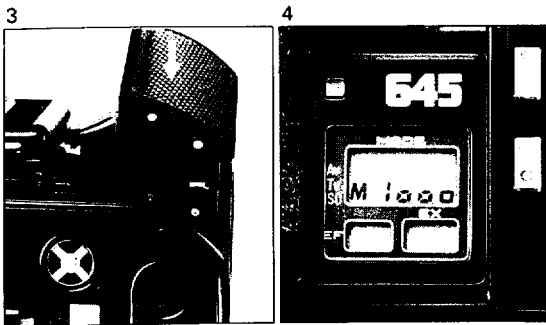

3. As shown in the illustration, battery holder should be inserted into the grip; depressing the same will insure firm locking. Confirm that the unit is securely locked into position.
4. Once batteries are properly in place within the grip, the LCD indicator will appear in the LCD window as illustrated. Should the LCD fail to appear, batteries are exhausted or are improperly inserted or the grip is not securely attached to the body.
5. A common battery source is used for LCD display and motor drive. For battery check, confirm the motor drive function which is affected earlier than that of LCD display.

### Precautions

- Make sure that polarities of all the batteries are properly aligned. Incorrect polarity alignment may cause unexpected damage to your equipment.
- Replace all batteries at the same time. Do not mix battery brands, types or old batteries with new ones.
- Remove batteries when not using your equipment for a long time. Batteries may tend to leak if left too long in your equipment and may cause serious damage.
- Never throw used batteries into fire since they may explode, causing unexpected damage or injury to you.
- Store batteries in a cool place, and out of reach of children.
- Batteries are very sensitive to cold and performance tends to deteriorate at temperatures near freezing point. Performance is restored as soon as batteries are brought back to room temperature. Keep a set of batteries in a warm pocket when shooting in cold weather to substitute if the others no longer perform well.

**Be sure to turn off the main switch to avoid unexpected battery drain, when putting your camera into a bag.**

## ATTACHING/REMOVAL OF GRIP 645

1



Confirm that the main switch located on the grip has been turned to OFF position.

### Removal:

1. Using a coin or similar tool, completely loosen the grip lock screw by turning the same in the direction opposite to the "LOCK" arrow designation.

2



2. While simultaneously depressing the grip lock screw, carefully pull the grip down, and withdraw the same out to the side. The grip will come away from the camera body.

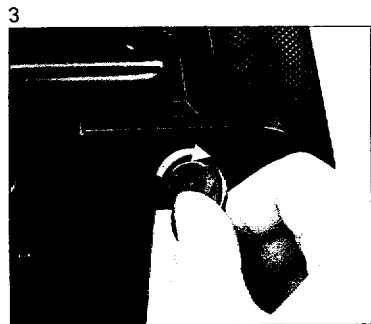
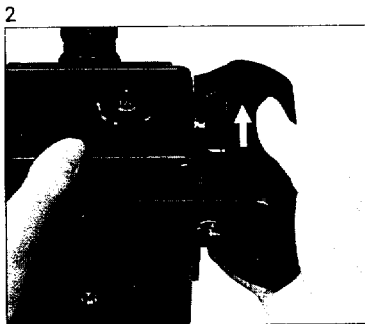
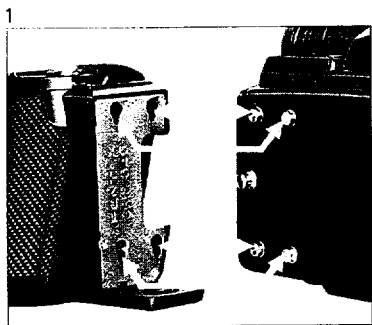

**Attaching:**

1. Loosen the grip lock screw. As indicated in the photographic illustration, align grip holes on the grip with the corresponding pins on the side of the camera.
2. Push up the grip until it engages with an audible click, signifying correct contact.
3. Turn the grip locking screw located on the bottom, in the direction of the "LOCK" arrow designation, using a coin or a similar tool.

## LENS MOUNTING/INTERCHANGE (Go over these instructions since this process will be required also when lens is already mounted.)

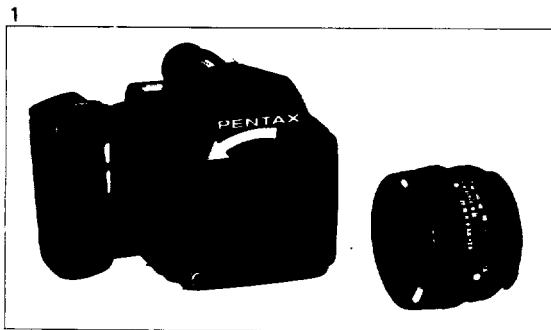

1. Depress the lens release button and turn the body mount cap to remove it.

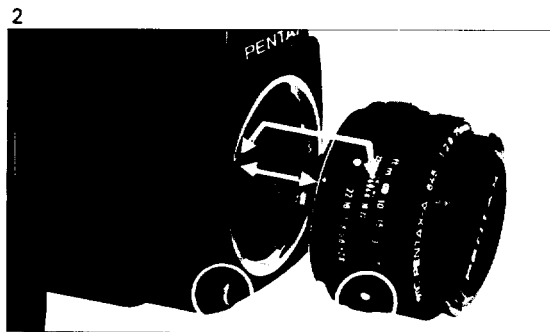

2. To mount the lens, align red dot (A) found on the camera body with red dot (B) on the lens unit, then seat the lens mount into the camera mounting. Turn clockwise until the lens locks with a click.

The procedure (C) illustrated is recommended in mounting lenses in a dimly lit area since the lens may be easily mounted by touch alone.

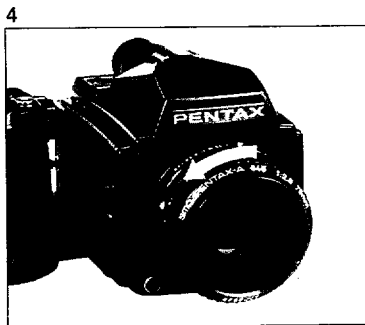
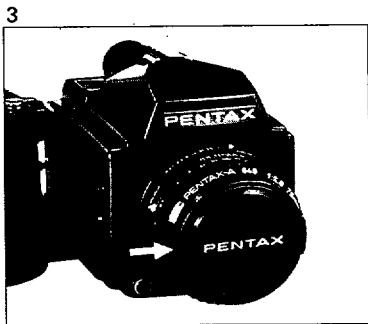

3. To remove/attach the lens cap, depress notches at both sides inward.
4. To remove the lens, depress the lens release button, and rotate the lens unit to the left. It will come out easily.
5. Following lens removal, the front and rear mount protective caps must be fitted to prevent foreign bodies and finger marks from accidentally gathering on the lens itself.

Note: Particular care must be taken in preventing damage or staining of the electrical contact points on the mount surface of the lens. A clean, dry cloth should be used to immediately wipe off any grease or accidental stains.

## ATTACHING SHOULDER STRAP

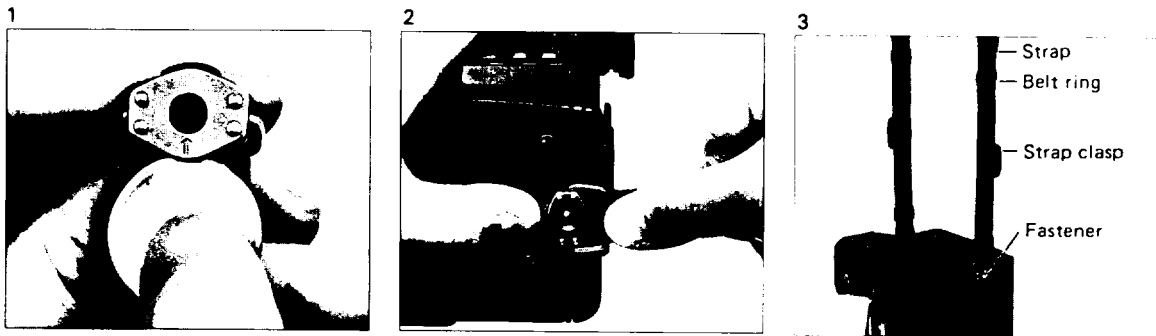

For carrying convenience, a shoulder strap can be attached to the camera by the lugs provided.

1. As illustrated, release lock by depressing the lock plate of the fastener in the direction of the arrow, using a coin.
2. Fit the strap lug into the opening of the fastener with its arrow facing out, and return the locking plate to the original position. It will securely attach to the strap.

To remove the strap, depress the lock plate in the same manner, and withdraw it from the lug.

3. To adjust the length of the strap, use the strap clasp.

\* After fitting the strap and adjusting the length, pull the strap hard on trial to see if the strap has securely engaged with the camera.

## FILM HOLDERS 645 AND ATTACHING/DETACHING

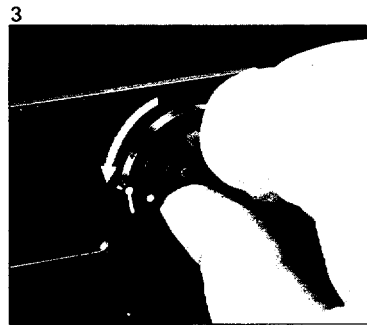
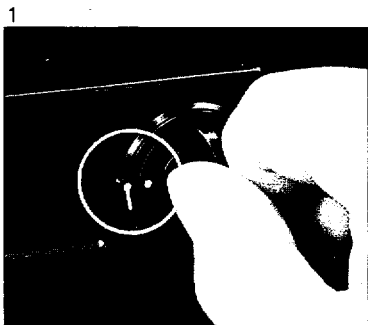

The following film holders are available, depending upon your photographic requirements; each provided with its own exclusive case for carrying convenience and protective purposes.

- 120 film holder: For 120 film (15 frames per roll)
- 220 film holder: For 220 film (30 frames per roll)
- 70mm film holder: For 70mm film (approx. 90 frames per roll)

### • **Attaching / detaching of 120/220 film holders**

When inserting the film holder into the camera body, be careful not to make its upside down to avoid any serious damage.

1. Align the red dots on the film holder and film holder key as shown, then insert the film holder into the camera chamber. Make sure that two tabs

lock in place with a film click when the film holder is inserted.

2. Lock it by rotating the film holder key 90° to the right while simultaneously depressing the key. After locking, the film holder key should be folded into its original position.
3. Raise the film holder key and rotate until the red dot markings are aligned. Continue to rotate the key counterclockwise up to the end of the red line; the locking mechanism will release with an audible click, permitting the film holder to be removed from the camera body. Refer to the 70mm film holder operating manual for its use.

## SHUTTER RELEASE WITHOUT FILM IN CAMERA

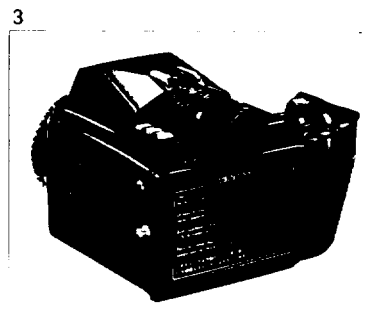
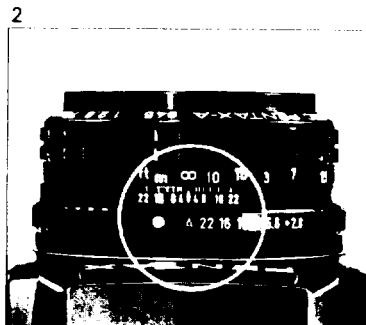
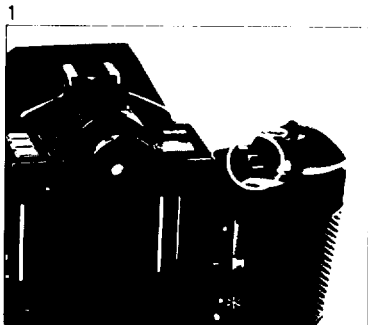

To release the shutter without film in the camera, remove the film holder or fix the rear body cap. The lens can be removed without affecting shutter release operation. However, such operation is not possible if the film holder without film is attached.

1. When releasing the shutter without the film holder, turn the main switch ON and then press the shutter button to operate the shutter. Be sure to set the C/S Switch to "S". Setting it to "C" may cause erroneous operation and/or functional problems.

Avoid releasing the shutter with the pin (indicated in the photo by the " " mark) being pressed, which may cause erroneous operations and/or

functional problems.

2. With the film holder removed, the available shutter speed is 1/1000 sec. only if the aperture ring is set to A (auto). Meanwhile, when the aperture is shifted to any of respective f/stops, the shutter can be operated at 1/1000 sec., 1/60 sec. or B (bulb). For details, see the pages 32 and 33.
3. When Rear Body Cap 645 is attached in place of the film holder removed, release the shutter once. Then the selection of each photographic mode, shutter speed and f-stop will become possible.



## PROBLEMS AND REMEDIAL SOLUTIONS

- Under the following conditions, the shutter release action will not be possible even though the shutter release button is depressed.
  1. Main switch is not turned ON.
  2. Batteries in the grip are depleted; no batteries in the grip; or the batteries incorrectly loaded.
  3. Film holder without a film has been installed in the camera's film chamber.
  4. The available film frames have been completely exposed.
- 5. **During photographic operations.**
- Should the exposure counter not register "1" or should a non-A lens be used even if the film be loaded in the camera, any photographic mode setting, or shutter speed and/or f/stop adjustments will not function. When an A lens is not set at "A", the photographic modes available at "A" (auto) position will be prevented. Also refer to Item 3 on the previous page.
- Film holder exchange is not possible in mid-roll. When the film holder is removed from the camera in mid-roll, the properly exposed film may be totally damaged and the LCD exposure count display returns to the starting position (no indication).

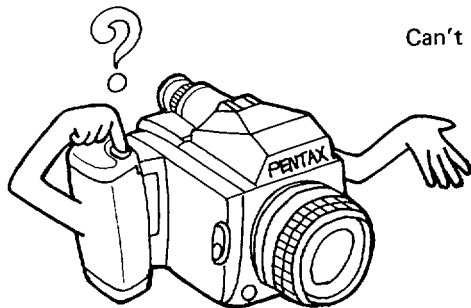

Can't release!

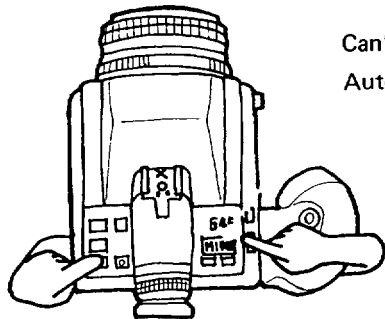

Can't set to  
Auto or P!

- Should dust, foreign bodies or film residues collect on the film holder or within the film holder chamber of the camera body, they may inadvertently register photographically; clean them off carefully to prevent problems. Should film residue or dust collect at the contact point (for film detection) located on the pressure plate side of the film holder, the motor will continue to rotate idly after all remaining frames have been exposed. However, in approximately 30 secs., the motor will stop turning. When the motor stops and the ON-OFF operation of the main switch is repeated, the motor will again be activated in idle rotation; however, avoid doing this, since it may cause problems with the film winding mechanism. After switching off, remove the film holder and clean the contact point of the pressure plate.

Keep it clean!

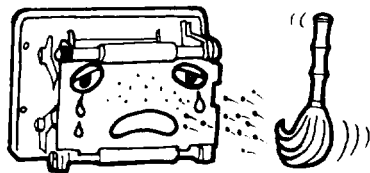

- Should the film winding operation stop before all available frames have been exposed, recheck the batteries in order to locate the possible cause of the problem.
- When using accessories without information contacts, set the aperture ring to the appropriate f/stops, with the exception of the "A" (auto) position which cannot be used under this situation.

Don't change  
the film  
in mid-roll!

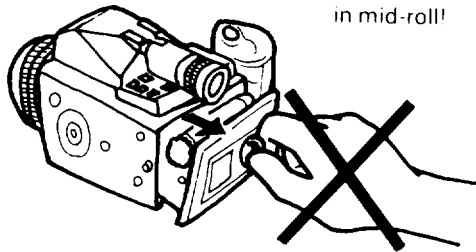

## **BASIC OPERATION**

## LOADING/UNLOADING FILM

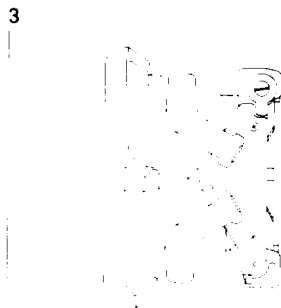
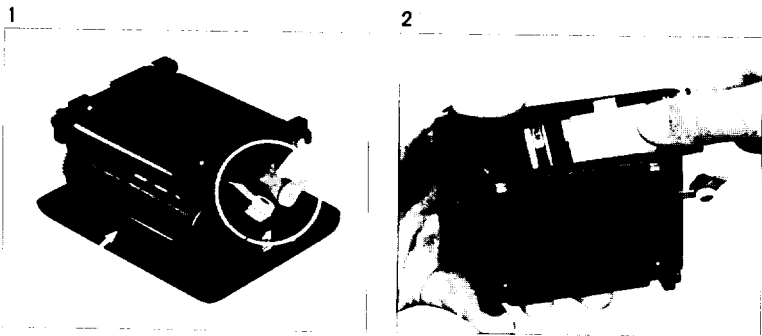

Always load or unload the film in a shady spot, or shield the camera and film from direct sunlight with your body. Insert the film and the empty take-up spool into the film holder, as indicated inside the holder.

- When exchanging the film, be sure to do it with the grip's batteries or power source (cord for remote-control operation) connected with the camera body. If the power source connection is done after the film exchange, the camera's shooting functions work properly, but the exposure counter does not automatically reset.

1. To transfer the emptied spool to the opposite side, push the spool retainer outward, and the hole of the spool should be set into the key (holder) so that both are engaged firmly. The retainer should then be returned to its original position.
2. A new film is to be positioned according to the film marking indicated, in the similar manner of the empty spool moving/setting; it is then secured with the spool retainer. [While loading a roll of film, securely hold onto the roll to prevent the backing (paper) from loosening. Carefully tear off the tape holding the paper leader.] The black inner side of the leading paper must face outwards.

4

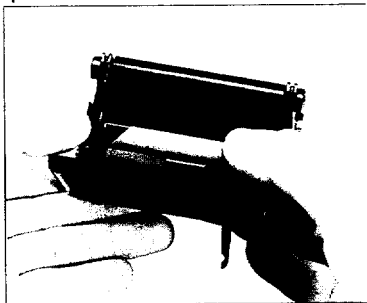

5

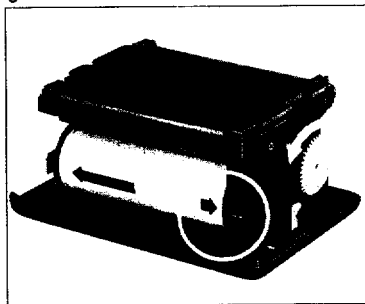

6

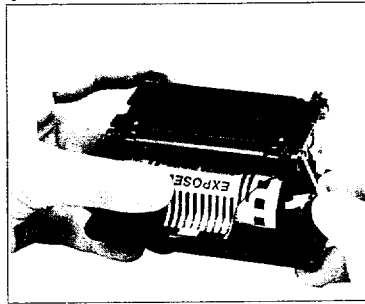

3. Draw the leader from the film roll, and insert the leader end into the take-up spool's slit. Slowly rotate the film winding gear by one turn in the direction of the arrow.
  4. Wind the leader paper upon the take-up spool until the arrow marking on the leader appears; it should be aligned with the holder's start mark S (red line).
- Care must be taken so that the leader paper's arrow marking does not go far beyond the holder's red dot, for you may lose the last frame(s) on the roll. Then attach the holder to the camera body according to the holder attaching/detaching instructions. Refer to p. 20 ~ 43 for shooting. After all of the frames on the roll have been exposed, remove the film holder from the camera, following the attaching/detaching instructions.
  - The built-in motor drive unit automatically stops as soon as the last frame is exposed and wound onto the take-up spool. Then the LCD exposure counter displays the number which is the total exposure number of the film in use, plus one. For example, 16 in the case of 120 film.
5. Take the film holder out, and you will see the exposed film wound on the take-up spool.
  6. While firmly holding the wound film roll, remove it after pushing the spool retainer out. Using the paper seal on the back of the paper leader, securely paste to prevent accidental unwinding of the exposed roll.

## C/S SWITCH, MAIN SWITCH AND SHUTTER RELEASE BUTTON

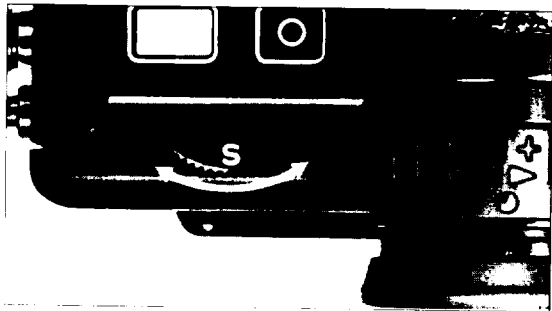

The Pentax 645 incorporates a motor drive unit, permitting either single or consecutive shooting through the C/S switch. Select either the C or S position by turning the C/S switch.

- **Single frame shooting (S)**

By depressing the shutter release button, a single frame is exposed and automatically wound to the next frame, at which point the motor halts.

- **Consecutive shooting (C)**

While the shutter release button is kept depressed, the frames are continuously exposed at about 1.5 frames/sec. Once finger pressure is released from the shutter release button, the motor will halt after winding the film to the next frame.

- **Main switch and shutter release button**

A light pressure upon the shutter release button with the main switch turned ON will immediately activate the exposure meter causing the LED indicator to appear in the viewfinder of the camera; further pressure on the button will release the shutter. A timer switch has also been integrated into the exposure meter circuit, and will automatically terminate power approximately 30 seconds after finger is removed from the release button.

- Turning the main switch off during exposure will result in incorrect exposure.

## LCD INDICATION FOR EXPOSURE COUNT (The first frame automatically set)

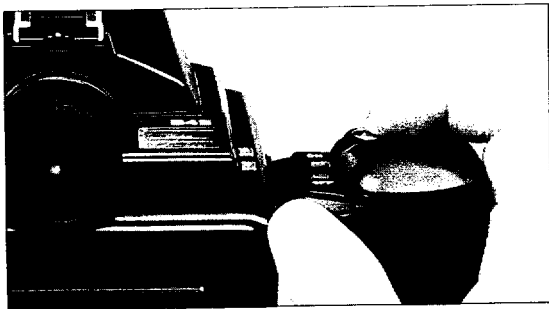

Turn the main switch ON, and the shutter is released by depressing the shutter release button; the paper leader will be automatically wound up to the first frame. 15 frames can be exposed using a 120 film roll and 30 exposures with a 220 film roll.

- When the 6-exposure 120 film is used with your camera, you can take about seven pictures. And, the shutter and the exposure counter LCD continue to work until about 12 exposures.

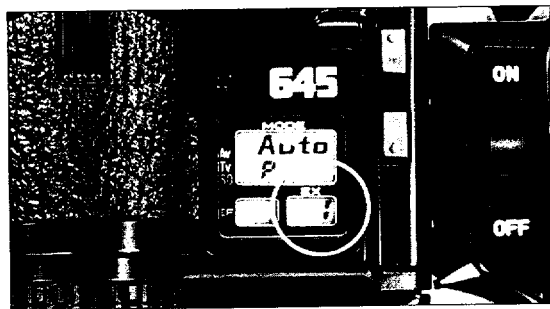

As shown above, the exposure counter LCD indicates "1."

During the shutter release operation, the LCD for the exposure count will flicker at one-second intervals, indicating that the given frame is being exposed. Thus, in the case of time exposure at the "B" (Bulb) position, exposure time can be accurately counted by flickering intervals.

When it is noted that the film winding speed slows or the motor fails to operate, the batteries should be replaced at once. When motor function slows extremely, intermittent motor noise can be heard.

## OPERATION PANEL AND LCD WINDOW

AV = Aperture Value  
TV = Time Value

Operation panel

④ LED button

⑨ LED film advance indicator

① Exposure compensation button

② Film speed button

③ Mode button

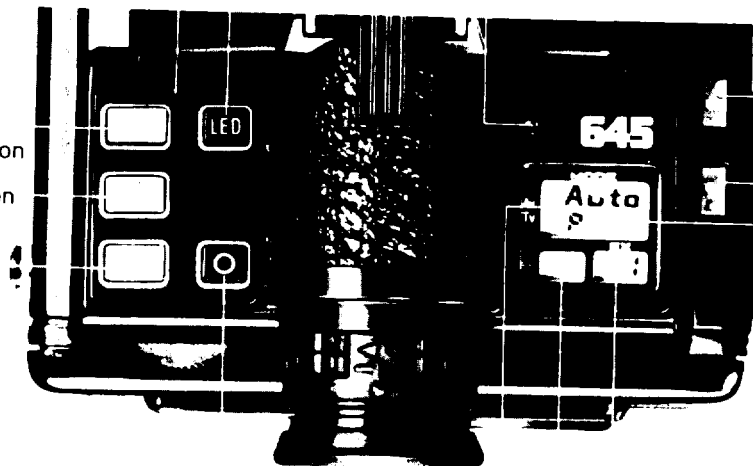

⑩ Selecting buttons:  
"up" (front)  
"down" (rear)  
LCD window

⑤ LCD illumination button

⑧ LCD exposure count

⑦ Exposure compensation LCD

⑥ LCD mode indication

**When you practice setting photographic mode, shutter speed or f/stop without the film holder, attach Rear Body Cap 645 in place and release the shutter once before commencing practice.**



- 1) Exposure compensation button
- 2) Film speed button
- 3) Mode button  
Exposure compensation, film speed and mode selection are activated by depressing the "up" (front) or "down" (rear) selecting button while depressing one of the three mode buttons. The depressing action of the button concerned will cause the LCD to flicker.
- 4) LED button  
The LED display circuit is activated by slightly depressing the shutter button. When the LED is not lit by this operation, depress the LED button to light the LED. To turn it off depress the LED button once again.
- 5) LCD illumination button  
Should the LCD indication appear somewhat dim in a dark area, the LCD window can be further illuminated by depressing the LCD illumination button to cause the indicator to become clearly visible.  
The light will go out by repeating the button depressing action; should the illumination be kept lit, it will still turn off automatically in approximately 12 seconds due to the built-in timer.

#### **Displays in LCD Window**

- 6) LCD mode indication  
Auto, P, 1000 to 15", F1.7 to 45, M, 60, B, LS,  $\frac{1}{2}$ , 6 to 6400 [ISO]
- 7) Exposure compensation LCD  
+3 ~ 0 ~ -3 (3 steps each for + and -)
- 8) LCD exposure count  
120 film = 1 to 16  
220 film = 1 to 31  
70mm film = 1 to about 90

#### **Film Advance Indication and Selecting Buttons**

- 9) LED film advance indicator  
This LED indicator is lit during the film winding operation.
- 10) Selecting buttons  
These two "up" (front) and "down" (rear) buttons are operated to select the desired photographing mode, shutter speed and aperture value; to adjust the film speed; and to set exposure compensation.  
Even when film is loaded in the camera, it is not possible to operate mode button or selecting buttons unless the film counter is set to the frame number ready for shooting, viz., the first frame or subsequent.

## FILM SPEED ADJUSTMENT AND MEMO HOLDER

Film speed designations are found printed upon the film packages, for example, indicated as "ISO 100". By pressing upon the film speed button, the film speed set previously will flicker in the LCD window. To change the given film speed display, depress the selecting button (either "up" or "down") while simultaneously depressing the film speed button; the film speed will change in increments of 1/3 **between ISO 6 and 6400**. By continuously maintaining the selecting button pressure, the changes will keep on.

The "ISO" designation is identical with the "ASA" film speed information.

"up" button → towards higher ISO  
"down" button → towards lower ISO

Tear off the top cover of the film package indicating the type of film and speed and insert the same into the memo holder provided on the film holder. The memo holder may also be utilized to jot down pertinent data by substituting a piece of paper for writing purposes.

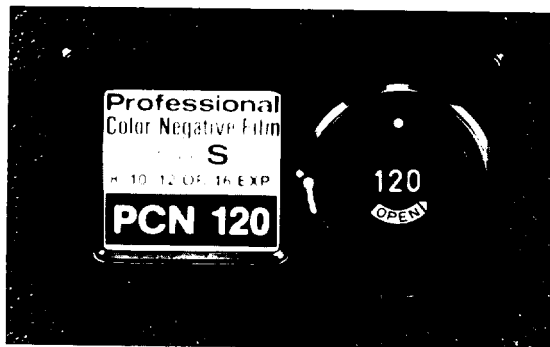
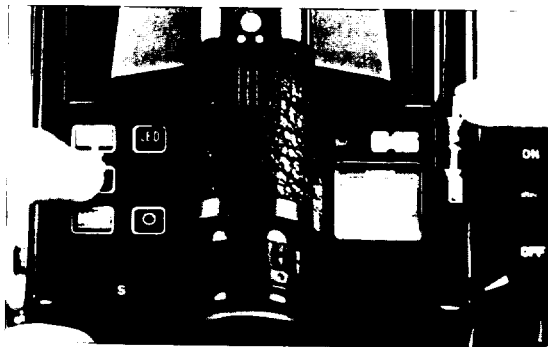

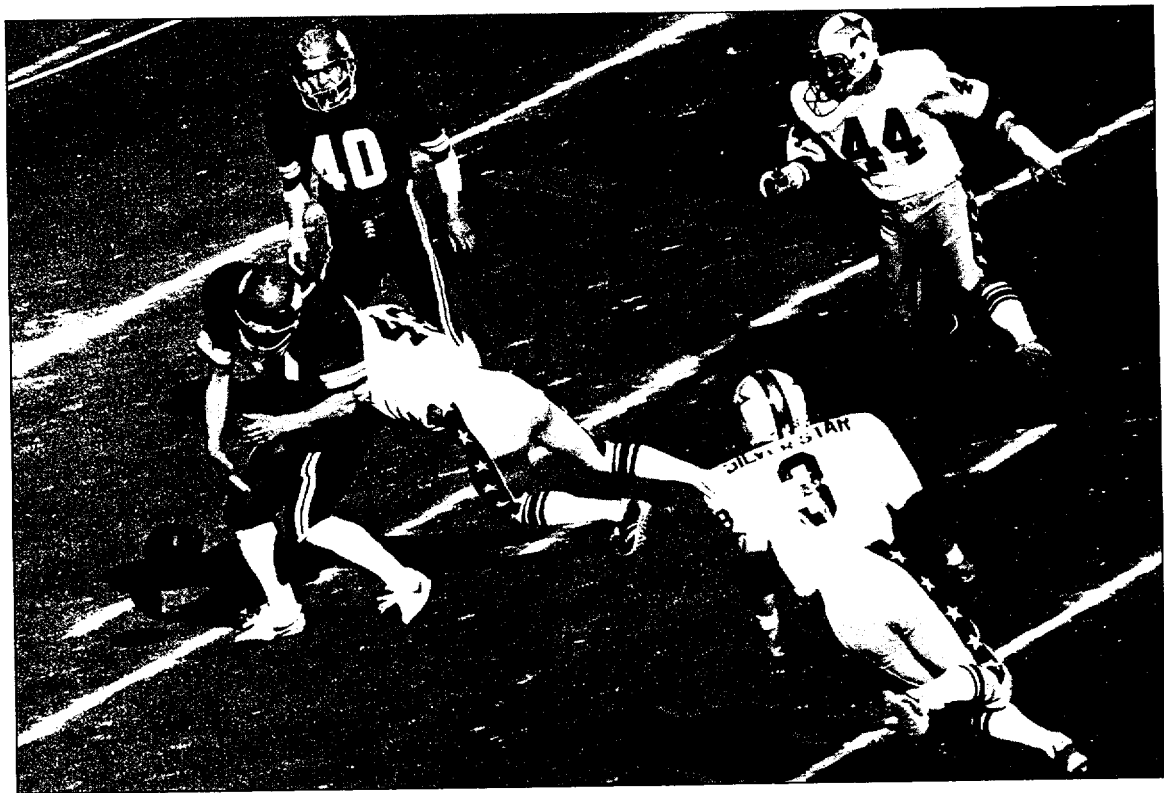

## VIEWFINDER DISPLAY

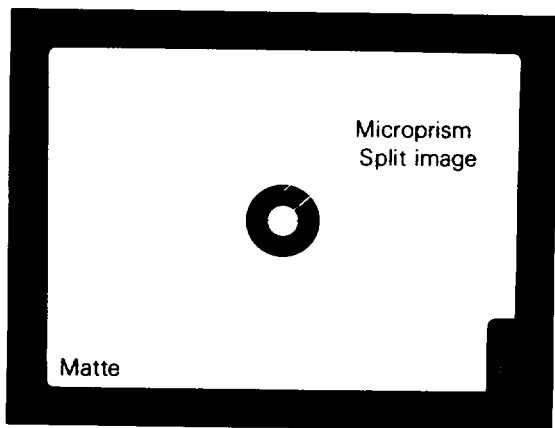

The shutter speed and f/stop are indicated via LED at the lower right of the viewfinder. In addition, other indicators are also found at the same location; flash data, exposure compensation warning, and leaf-shutter lens sign when utilized.

If the LED display for the shutter speed, f/stop, or  $\pm$  indication flickers like a flow, it may indicate that the photographic situation is "beyond the meter coupling range", or "exceeding the shutter/aperture coupling range".

(See also respective photographic modes.)

### Shutter information LED:

**1000** ~ **15''** ..... Shutter speed. 1000 indicates 1/1000 sec., and 15'', 15 seconds. Indications are shown in full-stop increments.

**B** ..... Bulb, or Time exposure

**—** ..... Flash recycling completion, including auto flash confirmation (when the exclusive dedicated flash unit is involved).

**L5** ..... This displays itself when a leaf-shutter lens is being used.

### Aperture information LED:

**F17** ~ **F45** ..... Aperture value F/1.7 through 45, displayed in 1/2-stop increments.



**F--** ..... No f/stop indicated in the following instances: When photographing in the Aperture-priority AE mode with the aperture ring adjusted to the appropriate f/stop; or when the shutter has been set to 60 (1/60 sec., fixed), or to B (Bulb).

**+ -** ..... Exposure compensation warning (flickering)

**03** ~ **OK** ~ **-3** ..... Employing the Metered manual mode, over or under exposures are indicated in steps; 03 to -3 ("0" denoting "+"). "OK" indicates "proper exposure".

Whenever the power source timer of the exposure meter has been turned OFF, the LED display within the viewfinder will vanish; however, the external LCD indications will remain visible.

## LED MODE WARNINGS IN VIEWFINDER

LED display	Meanings
	<p>Situation "beyond the shutter/aperture coupling range". Shutter speed or f/stop display flickers like a flow in sequence; adjusting the shutter speed or f/stop will correct this condition, and pictures may then be taken safely.</p>
	<p>Situation "beyond the meter coupling range". In respective modes, the displays of the f/stop and shutter speed will simultaneously register the flow-like flickerings in sequence to warn the operator. Photographing without compensation or adjustments will result in erroneous exposures.</p>
	<p>Exposure compensation warning. The + or - LED display flickers. This indicates that the exposure has been compensated with the exposure compensation button.</p>

- Normal flickering or flow-like flickering in sequence of the LED indicator within the viewfinder advises of several precautions.
- Some of the warnings, as examples, are set forth in the above table: (Examples may differ according to the maximum aperture of the lens in use, subject brightness, or ISO film speed.)
- "Beyond the meter coupling range" indicates that the exposure metering ability has gone past the maximum limit due to the fact that the subject's brightness range is either too high or too low to register effectively.
- "Beyond the shutter/aperture coupling range" means that the shutter speed/aperture combination has gone past the limit even if the situation remains within the range.
  - When the subject brightness range is too high, use an ND filter; if too low, use auxiliary light or high speed film to correct the problem.

## EYECUP 645

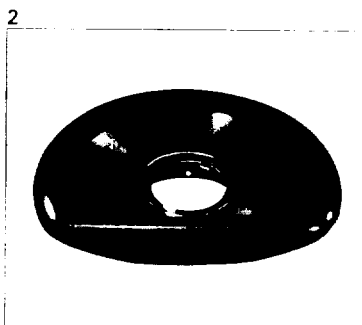
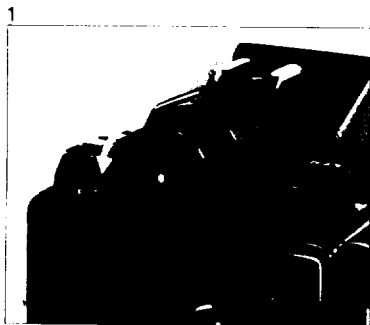

Two types of eyecup, a standard and another larger-sized one are provided as accessories; they may be utilized according to a given situation. The larger is constructed of rubber and designed to fit close to the face for easy shooting.

1. The standard eyecup may be easily detached from the viewfinder by rotating the cup to the left; to attach, the process is simply reversed.
2. In attaching the larger eyecup, first remove the standard eyecup, matching the eyecup pin with the fitting eyepiece hole.
3. The larger eyecup should be firmly affixed by turning the fixing screw to the right with a coin; detaching may be accomplished by reversing the previous action.

When using accessories such as the Refconverter 645, make certain that the eyecup is first removed.

## DIOPTR ADJUSTMENT

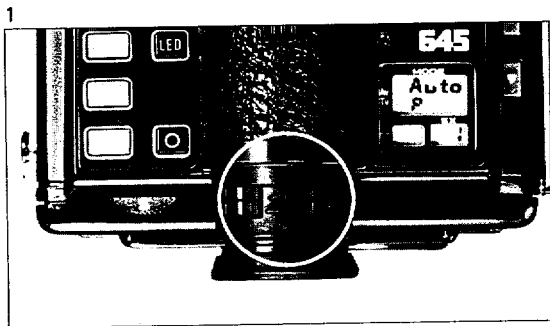

The eyepiece is equipped with a diopter adjusting ring. Accurate focusing of the viewfinder image becomes possible only with the diopter adjusting operation.

1. As illustrated, the diopter adjusting ring possesses a diopter adjusting index. Whenever the arrow indications of + and - appear at the top, it indicates that the ring is positioned at -1 dioptry. If far-sighted, rotate the diopter adjusting ring in the direction of the arrow for the + marking to the left side. However, should you be near-sighted, the diopter adjusting ring must be rotated for the - marking to the right side.

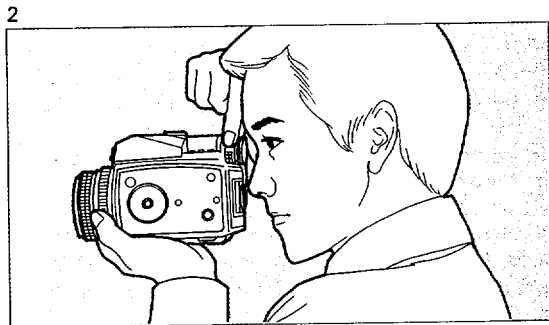

It is recommended that the diopter ring adjustment be performed prior to a shooting session to fit with your visual requirements, avoiding adjustments during picture taking.

2. To adjust diopter, as illustrated, direct the camera to face a bright/plain color background; then, rotate the diopter adjusting ring to a point whereby the border-line of the microprism and matte field can be seen most clearly. Adjusting is generally made easier when the focusing screen image is blurred or out of focus.

## FOCUSING PROCEDURE

View the subject through the viewfinder, and rotate the focusing ring of the lens. Focusing is possible in three ways; using split-image, microprism, and/or matte field. With the split-image method, the focusing ring should be rotated until the upper and lower image halves are perfectly aligned. When using the microprism collar, control focusing until glitter vanishes within the collar area. In the case of the matte surface, focusing should be adjusted until the image becomes sharp and crisp. At times, when the maximum aperture of the lens in use is limited in  $f$ /stop capability (less than  $f/5.6$ ; example,  $f/8$ ), the split-image or microprism collar may not render a satisfactory focusing view. In this event, the use of the matte field is recommended; or, an appropriate interchangeable focusing screen 645 (separately available) can be used. (Refer to P-62 for further details concerning this particular use.)

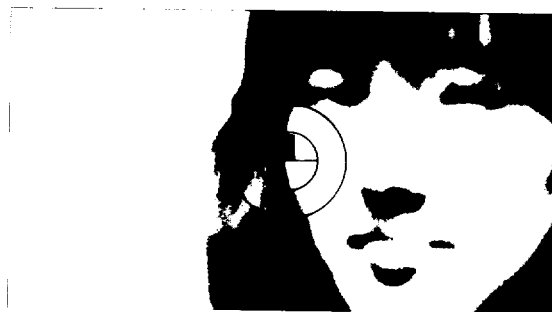

**Out of focus**



**In focus**



## RECOMMENDED CAMERA HOLDING POSITIONS

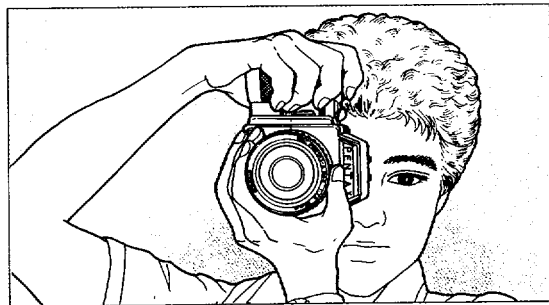

It is important that the camera be held correctly to minimize camera shake, which can result in blurred pictures. It is suggested that the Pentax 645 be handled for familiarization prior to actual use.

Basically, two methods of camera holding as illustrated, are recommended; both involving the secure holding of the camera against the face using both hands. The shutter should always be released gently; a sudden depressing of the shutter may cause an accidental camera shake situation. Stand with both feet firmly placed insuring a strong, steady posture. The left elbow should be drawn in contact with the body.

Utilizing a tree, wall, table, etc. to support the body

and camera will help in stabilizing grip and balance during picture taking.

When employing a slower shutter speed or a telephoto lens, it is highly recommended that a durable tripod and cable release (available optionally) be utilized to prevent camera shake and blurred pictures.

## SWITCHING TO "A" (AUTO) AND SETTING PHOTOGRAPHIC MODE

Aperture auto  
lock button

"A" (auto)

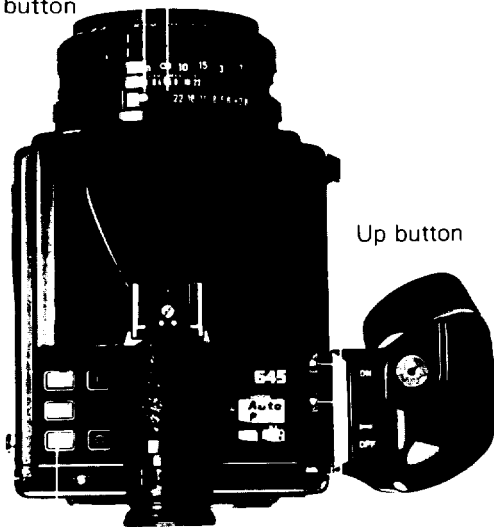

Up button

Down button  
Mode button

### Switching to "A" (Auto)

To set the lens aperture ring to the "A" (Auto) position, align the ring's aperture — "A" index (green) with  $\blacklozenge$  index while pressing the aperture auto lock button. To release the auto lock, turn the ring to the desired f-number (except "A") while pressing the "A"-lock button.

- Press the aperture auto lock button only when turning the ring from the "A" position to the largest f-number (f/22 in this case) or vice versa.

The following exposure modes can be set depending on the position of the aperture ring:

"A" (auto) 

Programmed AE
Aperture-priority AE
Shutter-priority AE

Respective f/stops  
(other than "A") 

Aperture-priority AE
Metered manual
60 (1/60 sec., fixed)
B (Bulb)

### Setting photographic mode

Depressing of the "up" (front) or "down" (rear) selecting button, while simultaneously holding down the mode button as in the picture, adjusts the photographic modes in the external LCD Window as shown on the right column.

### Setting f/stop and shutter speed

When employing either the Aperture-priority or the Shutter-priority AE mode with the aperture ring set at the "A" (auto) position, or when using the Metered manual mode with the aperture set to the respective f/stops, the selection of a f/stop or shutter speed is possible by depressing one of the selecting buttons. The LCD indicates an incremental change in steps by a single depressing of the selecting button, and continued changes by maintaining pressure upon it. The maximum point by moving the "up" button is 1000 (1/1000 sec.) or F22 ( ); the "down" button will stop at its lowest point of 15" (15 sec.) or F.2.8 ( ).

The f/stop will be displayed within the aperture range of the lens in use.

### Aperture set to the "A" (auto) position:

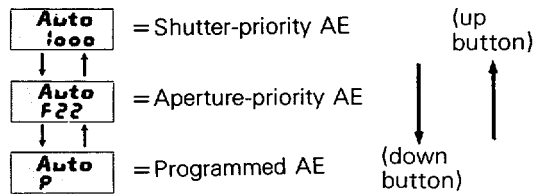

Displayed f/stop or shutter speed indicates the numerical value automatically set at the time within the camera's exposure control circuitry.

### Aperture set to each f/stop and also at the time of blank exposures:

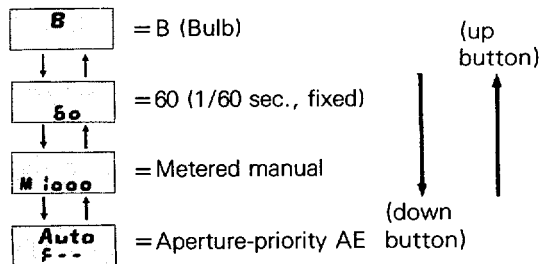

Only M 1000, 60 or B functions when releasing the shutter without a film holder.

## PHOTOGRAPHIC MODES WITH THE APERTURE SET AT "A" (AUTO)

**Programmed AE mode**  
**Aperture-priority AE mode**  
**Shutter-priority AE mode**

## PROGRAMMED AE MODE

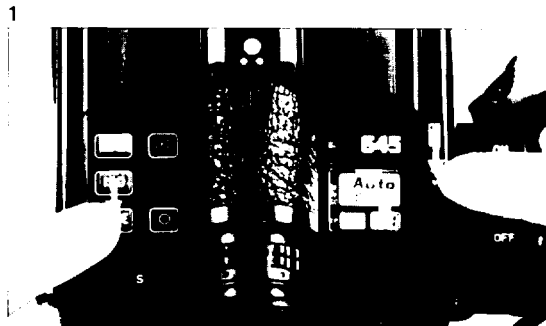

### Programmed AE

The Pentax 645 has been designed to control the f/stop and the shutter speed, which automatically vary at the same time depending upon the subject's brightness; thus, is able to determine the proper exposure. This feature is ideally suited for those who favour spontaneous or candid photography.

1. With the Programmed AE mode, "Auto" and "P" are displayed on the external LCD window. The camera mode can be switched to the Programmed AE by depressing the selecting button ("down"), while simultaneously depressing the mode button; this action will show Auto and P indications within the window.

2

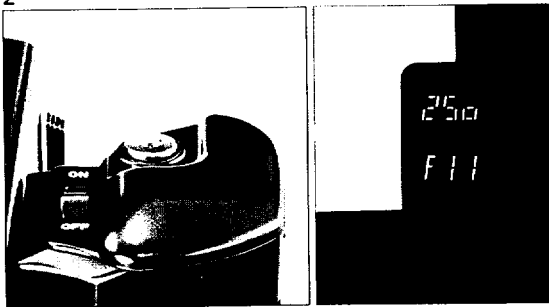

2. After turning on the main switch, a slight depressing upon the shutter release will reveal in the viewfinder LED the shutter speed and f/stop automatically programmed by the camera circuit. Additional pressure will release the shutter, enabling photographing.

### Visual warnings during Programmed AE control:

While utilizing this mode, and should the shutter speed and f/stop combination fall beyond the meter coupling range, the LED in the viewfinder will display the following indications; attempting to photograph the subject under these situations will result in an improper exposure.

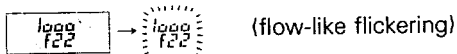

In this particular instance, the subject brightness is over the maximum range, or the given situation exceeds the meter coupling range of the Programmed AE mode. It may be remedied by either using a slower speed film or employing an ND filter available on the market.



In this instance, the subject's brightness is extremely low, beyond the meter coupling range of the Programmed AE mode. It may be corrected through the use of a higher speed film, or by supplementing with a flash/other artificial lighting unit(s).

## APERTURE-PRIORITY AE MODE

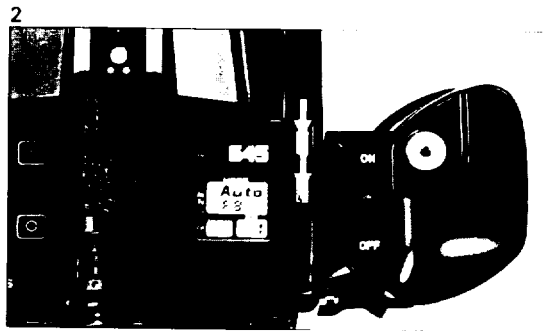

### Aperture-priority AE

Predetermine the  $f$ /stop to meet with a given photographic situation; the shutter speed will automatically adjust itself and provide the proper exposure in line with the subject's brightness. This method is ideally suited whenever the depth-of-field is considered important in general or portrait photography.

1. In this mode, the "Auto" and  $f$ /stop are externally displayed in the LCD window. Whenever a mode is switched from another to this particular setting, the display can be made visual by depressing the selecting button (either "up" or "down") and the mode button

simultaneously.

2. Desired selection of the  $f$ /stop can be effected with the depressing of the "up" or "down" selecting button. The "up" button should be operated when the aperture choice is toward the minimum aperture (example,  $f/22$ ); the "down" button, when the aperture desired is toward the maximum aperture opening ( $f/2.8$ , etc.). A single depressing moves the value in  $1/2$  incremental stops, while continuous  $f$ /stop increments are possible by maintaining pressure upon the selecting button.

3

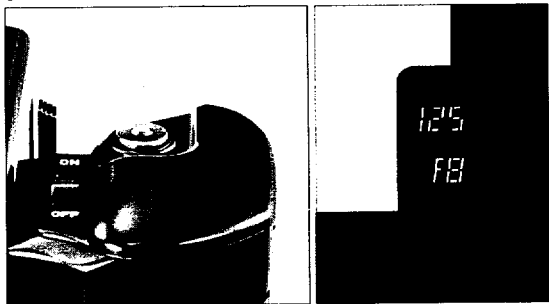

3. After turning on the main switch, the LED displays of the shutter speed and f/stop will visually appear within the viewfinder by a slight depressing of the shutter release button; additional pressure upon the shutter will cause the same to release for shooting.

### Visual warnings during Aperture-priority AE control:

The following indication will manifest itself within the viewfinder if the given photographic situation exceeds the shutter/aperture coupling range. The shutter speed will appear as follows:

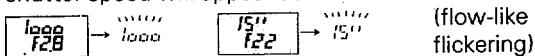

If the maximum aperture (f/2.8, etc.) appears, it should be reset by moving the same toward the direction of the minimum aperture (f/22, etc.). The process should be reversed in the similar manner, when the displayed value is the minimum aperture (f/22, etc.) by changing the aperture in the direction of maximum aperture.

Should the situation return to normal, that is, within the shutter/aperture coupling range by changing the f/stop, the flow-like flickering will cease and proper exposure is indicated and photographs may be taken in this AE mode. Whenever the situation exceeds the meter coupling range for proper exposure, the following shutter speed/aperture value indications will appear:

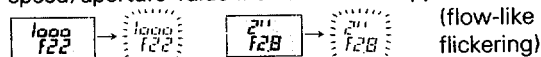

(Please refer to the section concerning "Beyond meter coupling range", page 27.)

## SHUTTER-PRIORITY AE MODE

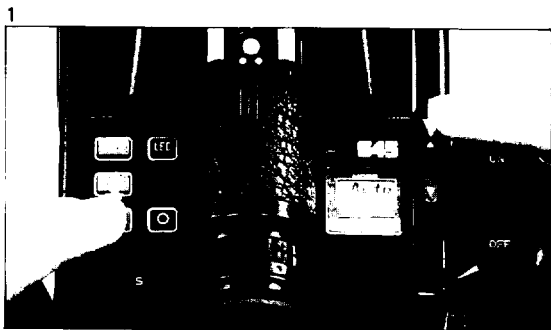

### Shutter-priority AE

The preselecting of a desired shutter speed will vary the aperture value automatically according to the subject's brightness. Proper exposure is controlled through the camera's AE capability. In addition to general photographic requirements, this mode is recommended for fast-moving subjects as found at sports events.

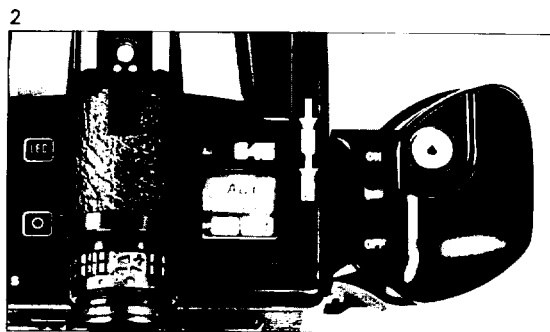

1. In this mode the external LCD window will indicate "Auto" and "shutter speed." If not, depress the "up" selecting button until the desired display appears in the window while simultaneously holding down the mode button.
2. Depress the "up" or "down" selecting button to set the required shutter speed. By depressing the "up" button, the speed is made faster; the "down" button depressing will slow the shutter speed. A single depressing will cause a single incremental change; the changing process becomes continuous in increments by holding it down.



3

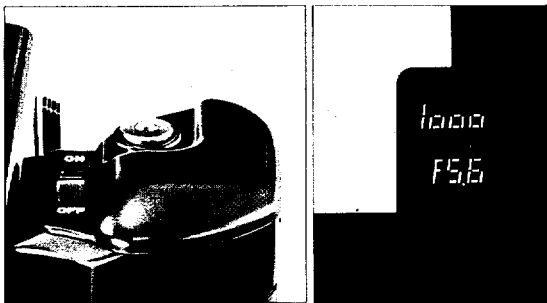

3. Turn on the main switch.  
By slightly depressing the shutter release button, the shutter speed and aperture value are indicated by the LED within the viewfinder. Additional pressure will cause the shutter to release, thus completing exposure.

### Visual warnings during Shutter-priority AE control:

The following aperture indication appears within the viewfinder, whenever a given situation is beyond the shutter/aperture coupling range.

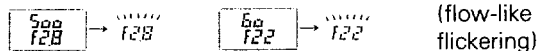

In the event the shutter speed is found to be somewhat higher, adjust the same to a slower point by setting the same in the direction of the "15" speed area.

When the speed is found to be slower, select a higher speed by moving the same toward the 1/1000 indication.

Should the situation return to normal, that is, within the shutter/aperture coupling range, by changing the shutter speed, the flow-like flickering in sequence will cease; proper exposure is indicated and photographs may be taken in this AE mode.

Whenever a given photographic situation exceeds the meter coupling range, the shutter speed and aperture value within the viewfinder appear as follows.

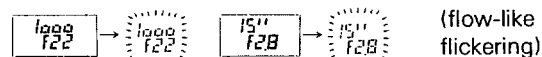

(Refer to page 27, "Beyond the meter coupling range".)

## APERTURE-PRIORITY AE MODE

1



PHOTOGRAPHIC MODES WITH THE APERTURE  
SET AT APPROPRIATE f/STOPS

**Aperture-Priority AE mode**  
**Metered manual mode**  
**60 (1/60 sec., fixed)**  
**B (Bulb)**

### Aperture-priority AE

The Aperture-priority AE control is possible by adjusting the aperture ring to any of the f/stops other than the "A" position.

This method requires the presetting of the desired f/stop; depending upon the subject brightness, the shutter speed is automatically controlled for proper exposure.

1. In the Aperture-priority AE mode with the f/stop presetted (not displayed), the external LCD window will indicate "Auto" and "F-". To effect a switchover to this mode from another, depress the selecting button ("down") while also depressing the mode button, to allow the LCD of this mode to appear within the window.

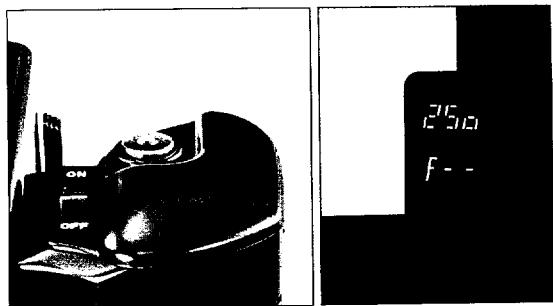

2. Rotate the aperture ring to select the desired f/stop. Turn on the main switch; a slight depressing upon the shutter release button will cause the LED indication of the shutter speed to appear in the viewfinder. Additional pressure on the button will release the shutter to photograph the subject.

### Visual warnings during aperture-priority AE control:

In the event light levels exceeds the shutter/aperture coupling range, the shutter speed within the viewfinder will be displayed in the following manner:

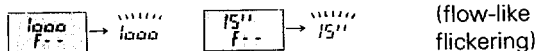

Should the maximum aperture be indicated, select a smaller aperture by rotating the ring toward the direction of its minimum aperture (f/22, etc.).

However, if the aperture displayed is the minimum aperture (f/22, etc.), rotate the same toward the direction of the maximum aperture (f/2.8, etc.).

When the combination reaches the shutter/aperture coupling range by changing the f/stop, the flow-like flickering in sequence will cease; proper exposure has been attained and photographs can be taken safely with this AE mode. Should the light level exceeds the meter coupling range the shutter speed and "F--" indication within the viewfinder will appear as follows:

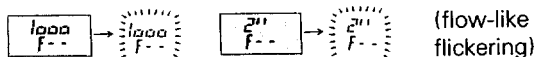

(Refer to page 27, "Beyond the meter coupling range.")

## METERED MANUAL MODE

1

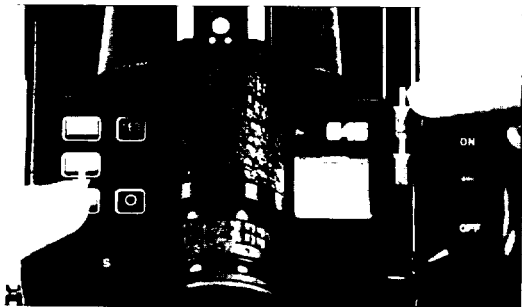

2

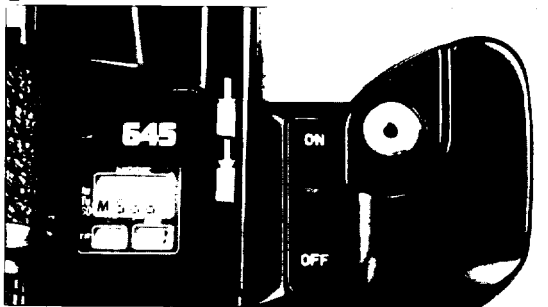

### Metered manual

Proper exposure is obtained by adjusting the shutter speed and f/stop according to the exposure meter indications visible in the viewfinder.

Utilizing this mode, the photographer is able to control the exposure value (over/under exposure) as may be required for his photographic purposes.

1. When using this Metered manual mode, the shutter speed is indicated in the external LCD window. In switching from another mode, depress the selecting button ("up" or "down"), while simultaneously depressing the mode button so that the manual mode "M" is displayed by the LCD.

2. Select desired shutter speed by depressing the selecting button ("up" or "down"). After turning the main switch ON, slightly depress the shutter release button; the shutter speed and one of the following numerical indications 03~OK~-3 will be displayed by the LED within the viewfinder. Factors 03~OK~-3 indicate the exposure amount (EV) in steps.

03	02	01	OK	-1	-2	-3
OVER			CORRECT			UNDER

For situations not covered by the  $\pm 3$  steps, 03 or -3 indication will flicker like a flow. "0" as shown in 01~03 indicates an "OVER" exposure situation.

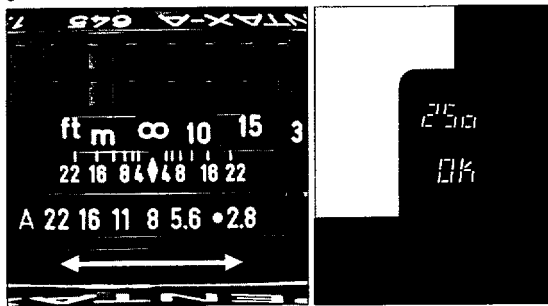

3. Control the aperture and/or shutter speed until the "OK" designation appears in the viewfinder, signifying "proper exposure". Intentional "over exposure" or "under exposure" for special effects to enhance the photographic subject is possible by adjusting the exposure within the range of the  $\pm 3$  steps. Then, having completed your own exposure determination, release the shutter to take the photograph.

#### Visual warnings during Metered manual mode

Excessive "over/under exposure" will be indicated in the viewfinder in the following manner:

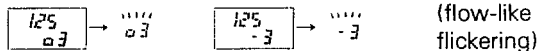

The flickering of "03" in sequence indicates that the exposure will render an over exposure exceeding +3 steps; that of "-3", an under exposure exceeding -3 steps.

Adjust either the shutter speed towards 1/1000 or rotate the aperture ring in the direction of the minimum aperture (F22). When an under exposure indication appears, set the shutter at a slower speed toward the direction of 15", or change the f/stop by rotating the ring in the direction of the maximum aperture (f/2.8, etc.).

Once the exposure amount display falls within the range of  $\pm 3$  steps, the flow-like flickering in sequence will cease; photographing may then be commenced.

If the photographic situation exceeds the meter coupling range, the following display will appear:

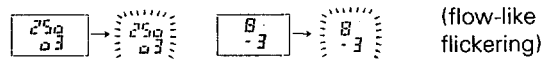

(Refer to the section "Beyond the meter coupling range" on page 27.)

## UTILIZING 60 (1/60 sec.) POSITION

1

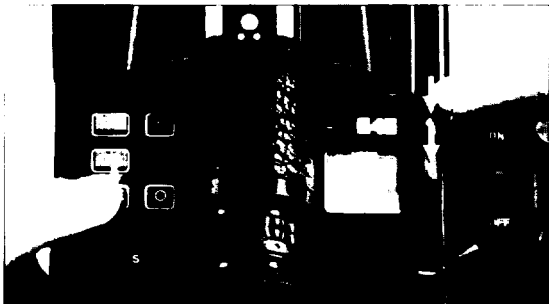

When using an ordinary flash unit with X synch. contact, select the 1/60 sec. flash synchronization mode. Although 1/60 sec. may be used for general photography without flash, there is no exposure meter indication.

1. The designation "60" is displayed within the external LCD window when the shutter speed is set at 1/60 sec. In the event another mode is displayed, a changeover to the 60 designation is possible by depressing the selecting button ("up" or "down") while simultaneously depressing the mode button. Turn the main switch ON; a slight depressing of the shutter

2



release button will display the LED indications of "60" and "F--" within the viewfinder.

2. During flash photography, adjust the f/stop according to the camera-to-subject distance. (For further details, refer to the operating instructions supplied with the flash unit.)  
When utilizing the Pentax 645 and a flash unit via a synch cord as illustrated, connect the cord to the camera's X-synch socket. The threaded synch cord plug may be screwed into this terminal.

## UTILIZING B (BULB) POSITION

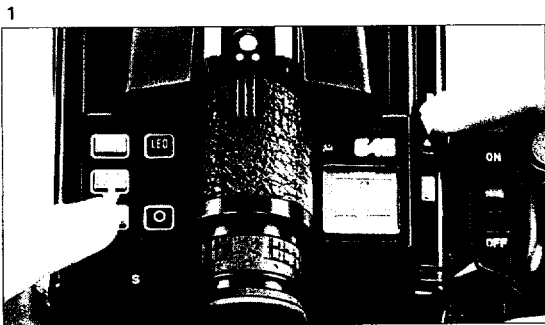

### B (Bulb)

The bulb position is used for time exposures requiring 15 seconds or more. While the shutter release button is depressed, the shutter will be open. The time exposures are recommended for firework displays, night scenery and/or astronomical photography.

Switching to the "B", the B display will become visible within the LCD window by depressing the selecting button ("up") while depressing the mode button at the same time.

With the main switch ON, depress the shutter button slightly, then, the "B" and "F--" will be

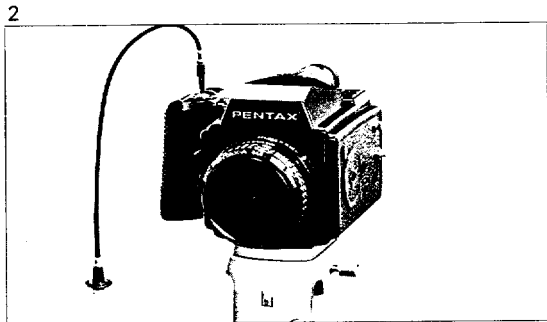



displayed by LED in the viewfinder. When shooting at the B position, it is recommended that a sturdy tripod and the Cable Switch A or a cable release (available optionally) be employed to prevent possible camera shake. The Cable Switch A or a cable release may be easily screwed into the shutter release button. Time exposures are made simple through the use of the Pentax Cable Release 50. Cable Release 30 is not recommended for use.

The long-time exposure consumes the battery power so greatly that even fresh alkaline batteries can be exhausted in about 40 hours.

## UTILIZING PENTAX DEDICATED FLASH UNITS

The compatible combination of the Pentax 645 and one of the Pentax dedicated auto flash units will allow convenient use as indicated in the table below. When using the AF400T, connect the unit to the hotshoe contact of the camera via the 4P synch cord B. Do not attempt to couple the cord

to the X-synch socket, otherwise, the camera's flash coupling capability will fail to function. A dedicated flash unit, when used with the Pentax 645, may not fire if the subject is too bright for flash photography.

FLASH COUPLING FUNCTIONS OF THE PENTAX 645	AF400T, AF280T AF200T, AF080C	AF260SA, AF200SA AF160SA, AF240Z
Upon completion of charging  will be displayed in the external LCD display window and  on the viewfinder LED display.		
With any photographic mode, the shutter speed is automatically switched to the synchronized speed of $\times$ setting (1/60 sec.), upon completion of charging. (When using an ordinary flash unit other than the dedicated TTL auto flash units, the aperture ring should be set to an appropriate f/stop other than the "A" positioning)		
If the aperture ring of the A lens is set to the "A" position, the 645's flash coupling function automatically switches the aperture to the necessary f/stop to enable TTL auto flash control.		
Whenever the auto flash unit has emitted an appropriate luminosity, a visual marking (  ) will light up or blink in the viewfinder, immediately after flash discharge.		
With the use of a dedicated TTL auto flash unit, the flash luminosity may be automatically controlled by the measuring of the light volume reflected off the film plane while photographing.		
When the Metered manual mode is used, synchronized flash photography is possible at shutter speed at 1/60 sec or lower.		

indicates Pentax dedicated TTL flashes



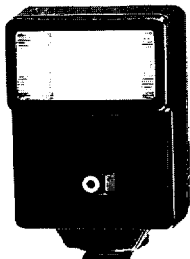

AF200Sa

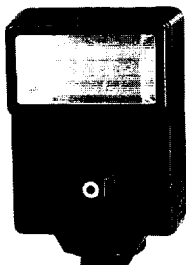

AF200T

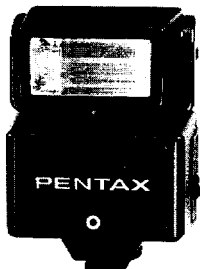

AF280T

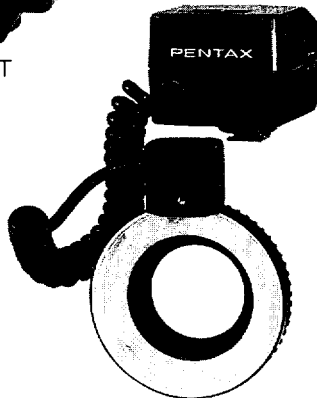

AF080C



AF400T

## TTL AUTO FLASH OPERATION

### TTL auto flash unit

As illustrated, the light entering through the taking lens strikes the film plane; a separate exclusive photo sensor registers the light reflected off the film plane and flash luminosity thereby is automatically controlled. Since only the light reflected from the subject is used for measuring purposes, an accurate exposure is obtained. All available f/stops on the lens may be also used for TTL auto flash control although there are some limitations regarding the flash-to-subject distance for each preset f/stop. Completion of flash charging automatically adjusts the shutter speed to the flash synchronization speed of 1/60 sec. The  $\rightarrow$  marking will appear in both windows to signify the completion of flash charging.

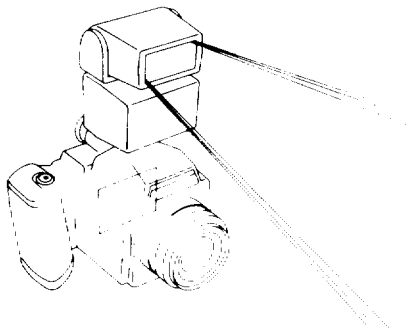

**Aperture set to respective f/stops** [either in Aperture-priority AE or Metered manual mode]

- Set the aperture ring to desired f/stop.
- Simultaneously with the completion of TTL auto flash charging, the viewfinder LED will indicate the flash synchronization speed of 1/60 sec.

**Aperture set to "A"**, [either in Programmed AE, Aperture-priority AE or Shutter-priority AE],

- Upon completion of the flash charging process of the TTL auto flash, the viewfinder LED display will indicate the flash synchronization speed of 1/60 sec. and the aperture of f/4 with ISO 100 film (f/8 with the AF080C ring flash).

With a film of a different speed, the f/stop will automatically change. However, the maximum flash-to-subject distance will remain unchanged. Refer to the operating manual of your flash unit.

The standard 75mm f/2.8 lens is the only one that can be used with the AF080C Ring Light. (Use the 58 → 49mm Adapter Ring to fit the flash on the lens.)

## PROGRAMMED AUTO FLASH OPERATION

- When combined with a Pentax dedicated auto flash (AF400T, AF280T, AF200T or AF200SA), a predetermined f/stop is automatically set, should the aperture ring be set at the "A" position.

The completion of flash charging will automatically switch the shutter speed to 1/60 sec. The  indication appears in the external LCD window and the viewfinder LED, indicating that the charging has been completed.

**Aperture set to "A"** [Programmed AE, Aperture-priority AE or shutter-priority AE],

- Adjust the flash mode selector of the AF200T, AF280T or AF400T, to the auto position (red, green or yellow).
- Simultaneously with the completion of the charging, the viewfinder LED display indicates 1/60 sec. According to the auto positions (red, green or yellow), the f/stop automatically varies as shown in the table below. (f/4 with AF200SA with ISO 100 film)

	AF200T	AF280T	AF400T
Red	f/2.8	F/4	f/4
Green	f/5.6	f/8	f/8
Yellow	—	—	f/11

(With ISO 100 film)

(Example: Should the selector of the AF200T be positioned at the "red" indication (ISO 100 film) the aperture automatically adjusts to f/2.8.)

As the film speed changes, the f/stop automatically changes; however, the maximum flash-to-subject distance remains unchanged.

Also refer to your flash unit operation manual.

**Aperture set at a given f/stop** [either Aperture-priority AE or Metered manual mode],

- Adjust the selector of the auto flash unit to "AUTO" position (red, green or yellow).
- Set the f/stop in accordance with the flash calculation guide found on the flash unit.
- With a dedicated auto flash unit, the completion of the charging automatically adjusts the shutter speed to 1/60 sec.

(In metered manual mode, flash synch at a slower shutter speed under 1/60 sec. is also possible.)

In this case, although you can set the exposure compensation button with the indication shown in the viewfinder, the exposure compensation function, in effect, does not work.

## Common use for TTL auto and external auto flash modes

### Flash synchronization at a slower speed:

In Metered manual mode, the shutter speed in the area of 1/125 sec. through 1/1000 sec. will automatically switch to 60 (1/60 sec.) with the completion of flash charging. All speeds slower than 1/60 sec. can be used for flash synchronization according to the requirements, thus permitting flash photography with synchronization at a slower shutter speed. Simultaneously with the completion of flash charging, the  marking indication will appear in the external LCD and within the viewfinder's LED.

### Auto flash confirmation mark ()

In each of the photographic modes, the auto flash confirmation marking will appear. Should the flash photography take place within the flash coupling range of the TTL auto flash units (TTL and the Programmed auto flash units), the  marking on the viewfinder's LED display will be lit or will flicker immediately following flash discharge, which indicates "auto flash confirmation". Its appearance assures that proper flash exposure has been rendered to the subject.

Flash coupling range to activate the auto flash confirmation mark may vary depending upon certain limitations according to the subject situation.

With the AF200T, the auto flash confirmation is also signified by an audible buzzing.

## DEDICATED FLASH PRECAUTIONS

- When setting the flash mode selector to MS (Manual synch.) or to the M (Manual) position utilizing a dedicated auto flash unit, adjust the aperture to the respective f/stops. The same procedure must apply to multiple flash operation. Setting to the "A" position will not provide proper exposure. The functions of the MS or M may vary depending upon the type of dedicated auto flash unit in use. It is recommended that the flash unit instructions be read and followed for optimum results.
- TTL and external auto flash operation is possible at 60 (1/60 sec. fixed) or B. When the shutter speed has been set at the B position, the B shutter speed will not switchover to that of flash synchronization, even when flash charging has been completed.
- Should the power switch of a dedicated flash unit be kept ON, the power source timer for the camera's exposure meter will be kept turned ON. Once the charging process has been completed, do not fail to turn the flash unit's power switch to the OFF position as soon as the flash is no longer required.

## USING ORDINARY FLASH UNITS

Shutter speed ranges for flash synchronization

Shutter speed	1/1000	1/500	1/250	1/125	1/60	1/30	1/15	1/8	1/2	1 ~ 15	B
Electronic flash units	Electronic flash unit										
Flash bulbs							MF flash bulbs				
							M and FP flash bulbs				

### Electronic flash units

When using a clip-on type flash unit equipped with a hot shoe bracket, attach the same directly onto the hot shoe of your Pentax 645. Should a cord be required for flash/camera connection, utilize a synch cord to fit into the camera's X-synch socket. As indicated in the above table, flash synchronization is possible at the shutter speeds from 1/60 sec. through 15 secs., and B.

It is recommended that other makes of flash units, particularly dedicated types for other cameras, or specific purpose types not be utilized; doing so may cause malfunctions and/or damage to the electronic exposure control system of the Pentax 645.

### Flash bulbs

By connecting a synch cord to the X-synch socket, the use of an independent flash gun is possible. With the MF type flash bulbs, select any of the shutter speeds from 1/30 sec. through 15 secs. including the B position; the M/FP type will permit flash synchronization within the range of 1/15 sec. to 15 secs. and B.

For detailed use of flash units, flash guns or flash bulbs, refer to the operational instructions on the respective units.

# PROGRAMMED AE DIAGRAM, METER COUPLING AND SHUTTER/APERTURE COUPLING RANGE

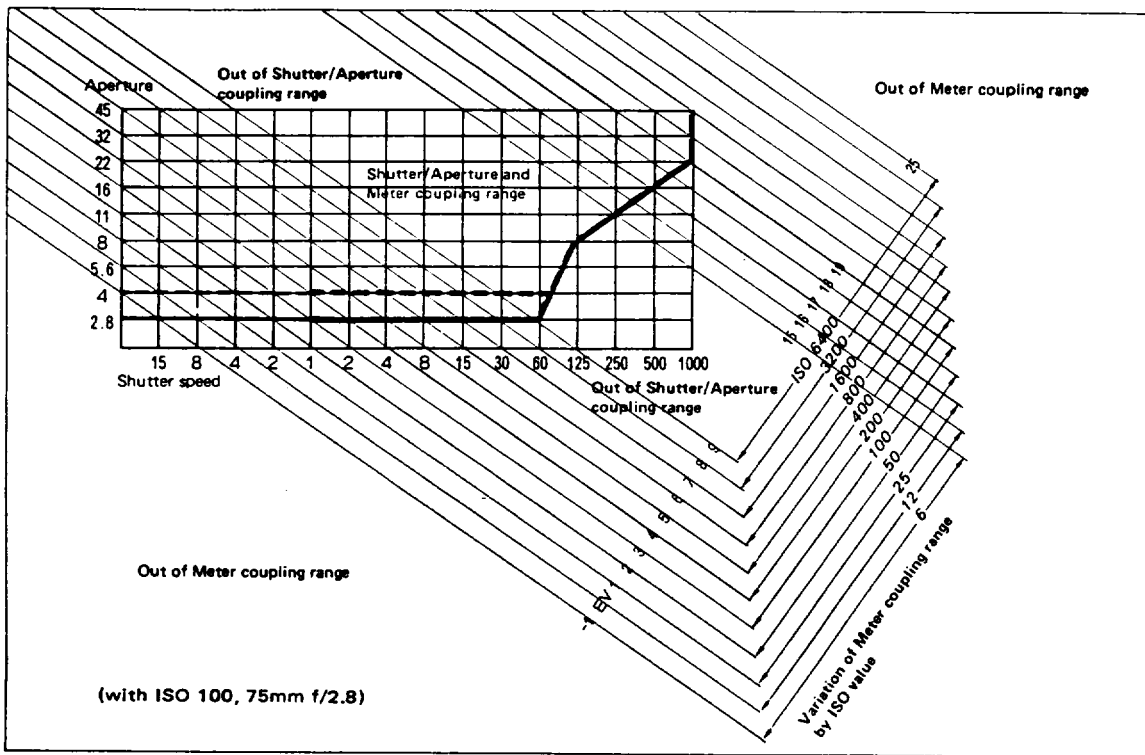

### **Programmed AE Diagram**

The Pentax 645's shutter/aperture combination in the Programmed AE mode is shown in the chart. The green line represents the variation of shutter speed and aperture combination with the standard 75mm f/2.8 lens (w/ISO 100 film). Note that only the shutter speed slows down after the lens reaches its limit of f/2.8 in combination with a speed of approx. 1/60 sec. Using a lens with a different maximum aperture, the exposure program varies the aperture and the shutter speed in combination until reaching the maximum aperture of the lens in use. For example, with an f/4 lens the program adjusts the combination as shown by the green dotted line. When using a lens with a different maximum/minimum aperture, or film with a different ISO film speed, refer to the fine green and dotted green lines seen in the Programmed AE diagram. The limit of the meter coupling range will vary if a lens other than the 75mm f/2.8 standard lens is utilized.

### **Meter Coupling and Shutter/Aperture Coupling Range**

Meter coupling range indicates the range of subject luminance within which the built-in exposure meter functions to control exposure.

The shutter/aperture coupling range is that part of the meter coupling range within which the shutter speed and f/stop can be combined for proper exposure control.

With the 75mm f/2.8 standard lens and ISO 100 film, the meter coupling range extends from EV 3 (f/2.8, 1 sec) to EV19 [f/22, 1/1000]. In the diagram at the left, the diagonal lines from the left top to lower right will move in parallel depending on the ISO rating.

The diagram within the frame illustrates the meter coupling and shutter/aperture coupling ranges.

#### **EV (Exposure Value)**

EV represents the amount of exposure by a combination of the shutter speed and lens aperture, determined by the film speed and the brightness of the subject.

## SPECIAL TECHNIQUES

Meter-sensitivity pattern (EV)

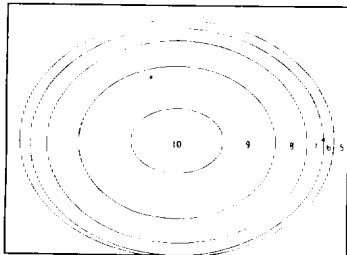

## EXPOSURE COMPENSATION

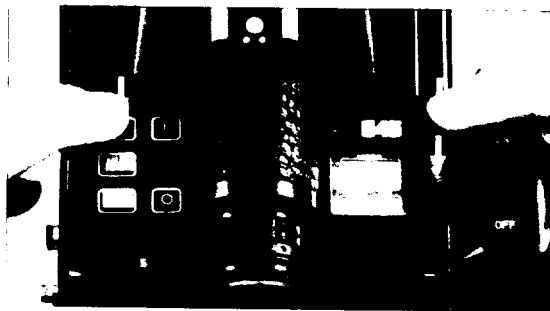

Automatic exposure cameras tend to underexpose backlit subjects and to overexpose spotlighted subjects appearing on a stage, etc.

To increase the exposure determined automatically against a bright background, the +1, +2 and +3 compensating controls are provided.

To decrease the exposure of the subject spotlighted against a dark background, the -1, -2, or -3 compensating controls are used.

The compensating controls are operated by depressing the selecting button ("up" or "down") while depressing the exposure compensation button [ $\pm$ EF] at the same time. When depressing only the exposure compensation button [ $\pm$ EF], the EF information flickers in the external LCD window. When the exposure compensation is utilized, the



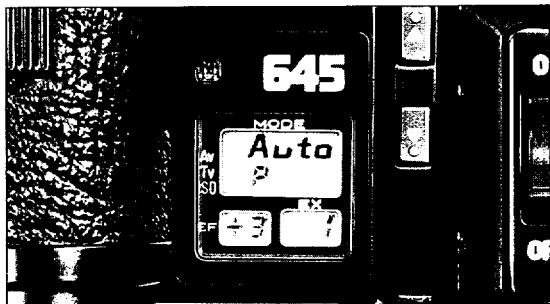

compensation index in use will be indicated on the EF display in the external LCD window. The + or - LED flickering sign in the viewfinder above the f/stop information will also be seen. Return to "0" position immediately following use. Exposures may be compensated automatically by adjusting the shutter speed in Aperture-priority AE, the f/stop in Shutter-priority AE, and the programmed value in the Programmed AE.

When photographing in Metered manual mode, the correct exposure sign 'OK' must be first obtained, then compensate by adjusting the shutter speed or f/stop.

In LS, 60 and B mode, exposure compensation does not work although due information is displayed.

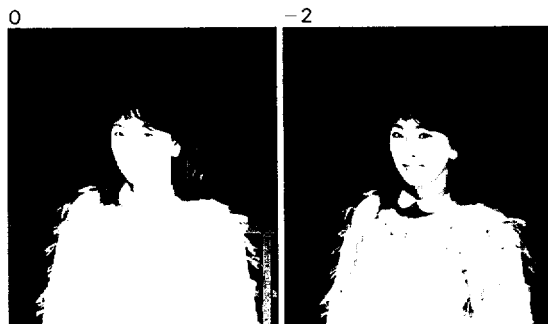
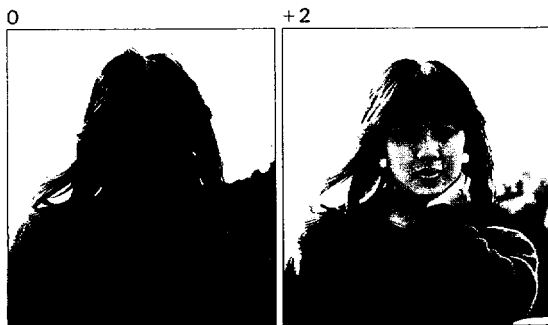

## DEPTH-OF-FIELD

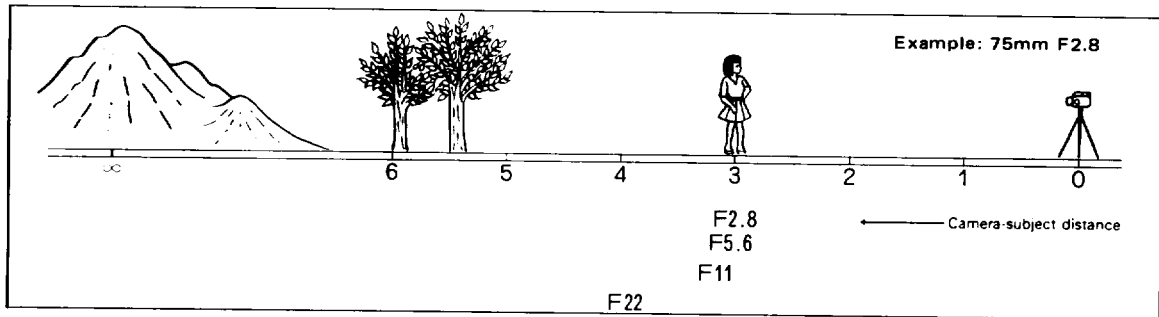

Depth-of-field is the area between the nearest and farthest points which are in proper focus at a given lens aperture.

The depth-of-field increases as the aperture becomes smaller; as the focal length of a lens becomes shorter; or the camera-to-subject distance is extended further back. By varying the f/stop, the range "in focus" will change accordingly, allowing the creating of different photographic effects in your pictures.

As illustrated in the pictures on the right page (examples of f/2.8 and f/22), the range "in focus" can be easily confirmed by checking the depth-of-field scale on the lens and previewing through the viewfinder (See page 58.)



f/2.8 [2.83 ~ 3.20m]



f/22 [2.04 ~ 5.82m]

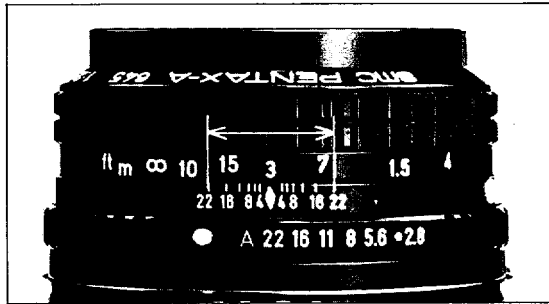
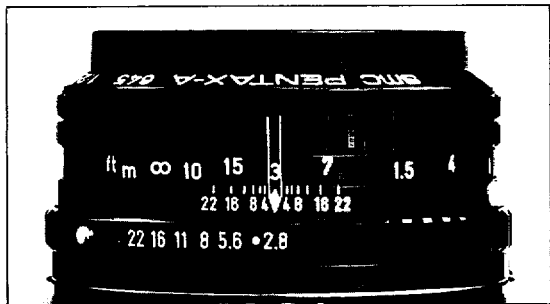

## DEPTH-OF-FIELD PREVIEW

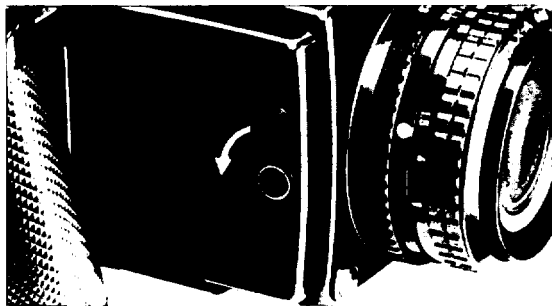

Should the lens possess an automatic diaphragm, the viewfinder can be kept bright with the aperture fully opened regardless of the preset  $f$ /stop. When the **preview lever** is depressed in the direction of the arrow, aperture will stop down to the preset value, and the depth-of-field can be confirmed through the viewfinder. The aperture will return to maximum when the **preview lever** is released. The depth-of-field cannot be confirmed while the lens is set to "A".

**Note:** Exposure value measured during preview may register incorrectly. While depth of field is being previewed, the shutter cannot be released.



## MULTIPLE EXPOSURE

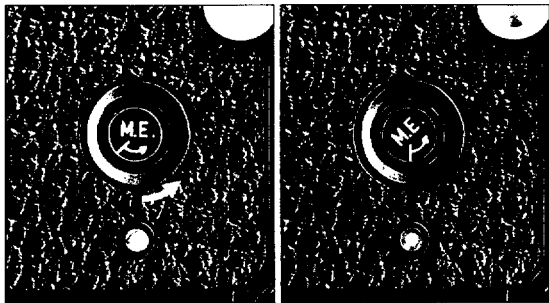

Setting multiple exposure is possible by pushing and simultaneously turning the multi-exposure ring in the direction of the arrow. When the shutter is released while in this state, the first exposure is made. Repeat the same for the second or third exposure, so that multiple exposure can be made on the same frame; only the shutter is cocked without film being advanced. The multi-exposure ring (M.E.) will automatically return to its original position immediately after shutter releasing function.

When cancelling multiple exposure, simply return the multi-exposure ring to its former position. After loading film, multiple exposure should not be

operated until the external LCD window exposure counter (EX) reads out "1" or larger. Should the shutter be accidentally released in this state, the motor will merely continue to run idly for about 30 seconds without winding the film.

In this case, turn off the main switch, take out the film holder once and cancel the multi-exposure ring setting. Then, newly start the correct procedure.

Set the C/S switch to S position when using the multiple exposure.

### **M.E. = Multiple Exposures**

#### **Multiple exposure operational sequence:**

1. Set the multi-exposure ring
  2. Initial photographing of the subject
  3. Reset the multi-exposure ring
  4. Secondary photographing of desired subject.
- By repeating the steps 3 and 4, multiple shots on a single frame are possible. Exposure counter indicator will remain stationary. To return to normal shooting, just release the shutter without setting the multi-exposure ring.

## TRIPOD SUPPORT

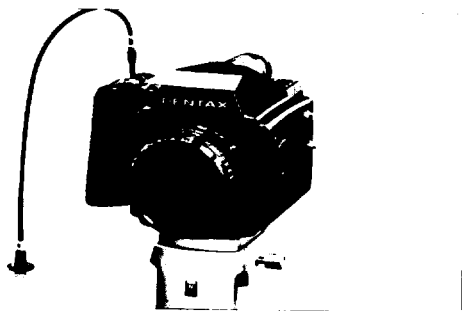

When photographing at slower shutter speeds, the use of tripod and cable release is suggested to prevent possible camera shake. As illustrated, the Pentax 645 has been provided with two tripod sockets for vertical and horizontal format positioning of the camera. In both positions, the sockets have been specially devised to align closely with the optical axis of the lens.

To check the exposure data when the Cable Switch A or Cable Release is used, push the Cable Release halfway with your finger.

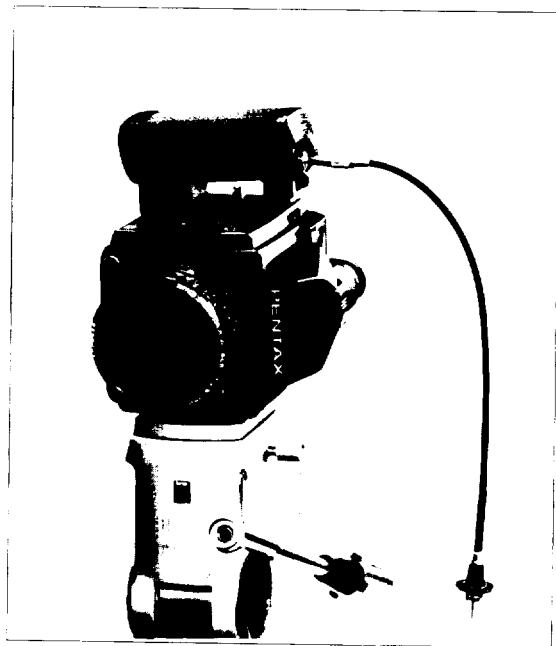

## INFRARED INDEX MARK

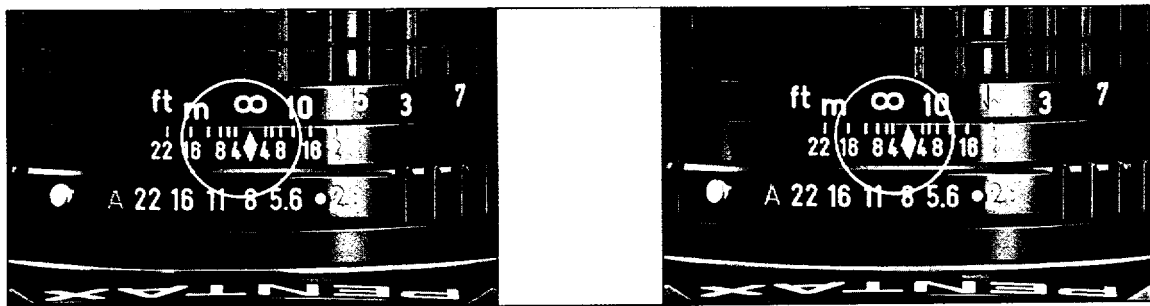

1. Adjust the distance scale (set at the "in-focus" point).

2. Then move to the red infrared index mark.

In the taking of infrared photographs using infrared film and R2 or O2 filter, it will be necessary to compensate for the difference between the visible light and infrared light focus.

As illustrated, read the camera-to-subject distance on the distance scale of the lens while focusing through the viewfinder; turn the focusing ring until the distance setting aligns with the red infrared index marking (red line). The picture shows an example where the camera-to-subject distance is set at infinity ( $\infty$ ).

For exposure control required in infrared photography, refer to the instructions contained in the film package.

## INTERCHANGING FOCUSING SCREENS

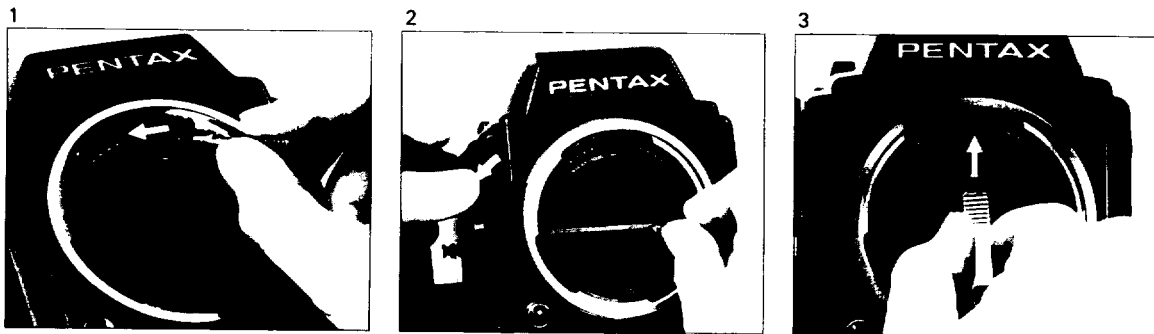

To interchange the focusing screen (F. S.), it will be necessary to first remove the lens from the camera body and turn off the main switch.

1. As seen in the photo, firmly hold the camera with the lens mount facing up, and slide the focusing screen release button in the direction of the arrow, using the tweezers supplied with the new focusing screen set.
2. The focusing screen will release together with the retaining frame. The left lever located within the lens mount should be held down by depressing the preview lever. Remove the focusing screen from the frame with the same tweezers, and fit it into the groove in the case

of the focusing screen to be replaced.

3. Carefully place the new screen on the frame using the tweezers provided while depressing the preview lever. Push the frame up utilizing the other end of the tweezers as illustrated, until it snaps into position.

The focusing screens are made out of a special optical plastic; thus, careful handling is essential. To clean, use only a blower to blow away the dust. It should be handled only with the exclusive tweezers, held by the edges as illustrated.



## INTERCHANGEABLE FOCUSING SCREENS

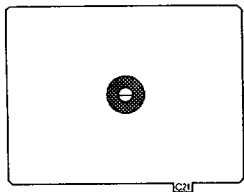

### UC-21 Split-image Microprism Matte

- The UC-21 focusing screen is built-in standard focusing device for general use; the split image covers an area of 3.5mm in diameter, while the microprism area is 8mm in diameter, including a prism angle of  $6^\circ$ .

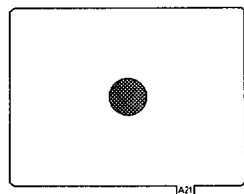

### UA-21 Microprism Matte

- For general use, with a microprism area of 8mm in diameter, and prism angle of  $6^\circ$ .

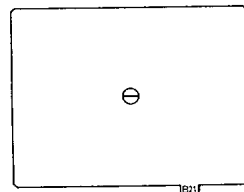

### UB-21 Split Image Matte

- General purpose screen possessing a prism angle of  $6^\circ$ . When combined with a lens with a maximum aperture smaller than  $f/5.6$ , the plain matte area is utilized for focusing.

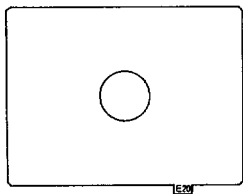

### UE-20 Plain Matte

- All the screen surface except for the central spot (11mm diameter) is covered by the fresnel lens, and has been designed for the slower speed lenses with a maximum aperture smaller than  $f/5.6$ ; situations under which microprism and split-image areas are not clearly defined in focusing.

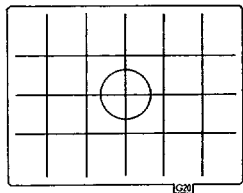

### UG-20 Section-line Matte

- A variation of the UE-20 plain matte screen; it includes sectional lines. Intervals of both vertical and horizontal lines are 9mm. It is suited particularly for the precise composing of a subject or for checking vertical or horizontal lines.

## MANUAL FILM WIND

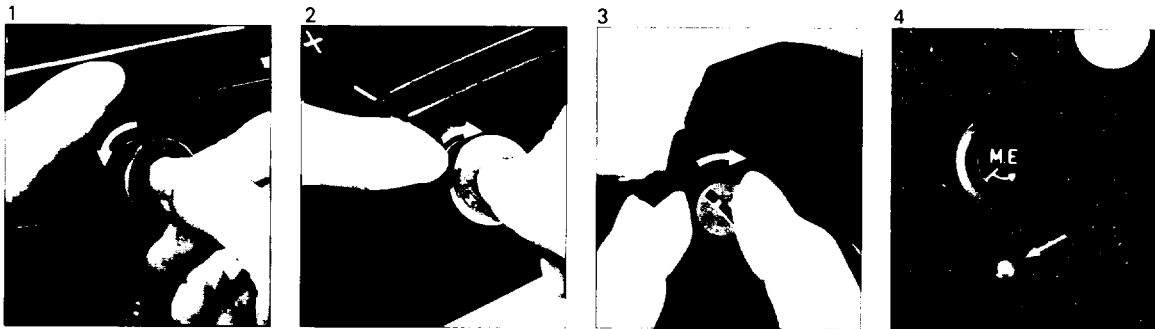

Manual film wind is possible during photographic functions, in the event motorized film advance has unexpectedly halted due to a drop of battery voltage; the remaining film may be manually rewound for removal.

Although continued photographing with the manual film wind is possible, it is not recommended for doing so since the shutter speed is fixed at the 1/50 sec. only.

1. Turn the film wind knob located at the bottom of the Pentax 645 counterclockwise using a coin or a similar tool, and remove it.
2. Thread the manual film wind knob into the small screw opening provided on the camera body,

and firmly tighten the screw knob with a coin or an appropriate tool. The cap removed can be accommodated and stored in the film wind knob chamber to prevent accidental loss.

3. Should the motor stop prior to the automatic film winding operation, wind the film manually by turning the knob clockwise as shown. Although an audible clicking may be discerned while winding, disregard the sound and continue to wind.
4. When the red mark fully appears in the "shutter cocked" indicator, manual film winding has been completed with the simultaneous shutter cocking. A film wind stop device has not been

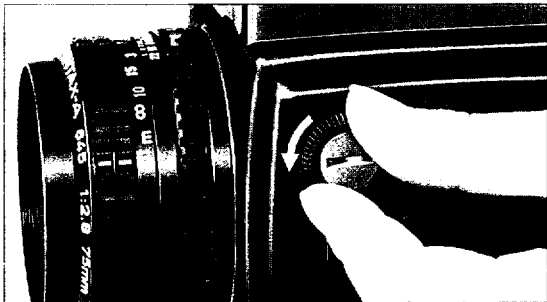

incorporated for the manual film winding. Even when a frame has been completely wound, the knob will continue to turn without engaging for the film winding/shutter cocking function.

5. By turning the knob slightly counterclockwise after completing a single frame winding, the shutter can be released and the reflex mirror kept at the up position. The mirror will return when the film is wound manually for the next frame. When you finish winding the designated number of frames of the roll by repeating the above procedure, you can continuously wind without releasing the shutter till it is completely wound up on the spool. After completing film winding operation keep the

film winding knob at the bottom of the camera body.

#### Notes:

- Should the knob be accidentally turned counterclockwise while you are winding manually, light leakage on the exposed film may occur through the fine slit of the shutter curtains. Precautions must be observed to avoid turning the knob in the opposite direction for this reason.
- Avoid leaving the camera with the reflection mirror in the raised position in bright light, since light leakage may occur following shutter release. In addition, directing the camera in this state toward the sun could cause the shutter curtains to scorch through the rays of the sunlight. Before replacing with new batteries in the grip, do not fail to remove the film winding knob; else, the motor-driven film winding operation (restored due to the battery replacement) will also activate the manual film wind knob to simultaneously rotate at a rate of high speed. Finger or hand injuries could result if they are in contact with the knob at the time. To avoid overlapping, do not release the shutter before the red marking in a full circle becomes visible in the "shutter cocked" indication.

## MAINTENANCE

The Pentax 645 is a precision instrument. Please read the following instructions concerning handling/maintenance.

- Do not drop or strike the camera against solid objects. In the event the camera may have sustained a heavy blow or shock, it is recommended that it be taken to an authorized Pentax service facility for inspection and possible repair.
- Should the camera become drenched either by rain or water, wipe off with a soft dry cloth as soon as possible. When used at the beach or while boating, wipe off the exposed sections as soon as possible; salt air/moisture damage may occur if left unattended for long.
- Do not leave or store the camera in a hot and humid location; for example, the temperature of an automobile interior during the summer tends to rise rapidly. Gaseous release from insecticides such as naphthaline may also prove harmful to the camera. Camera should be stored in a cool, well-ventilated area if at all possible.
- The temperature range at which your camera will continue to function properly extends from 50°C to -20°C. Extremely low temperature reduces the efficiency of the batteries. Therefore, the camera should be protected against low

temperature conditions. Sudden changes of temperature will often cause condensation of moisture within or on the exterior of the camera. Do not subject the camera without proper insulated protection to sudden temperature changes; out into the cold outdoors from a warm room, or vice versa. It is suggested that the camera be placed in a vinyl bag; allow a wait of approx. 30 minutes for each 10°C change of temperature, before removing the camera.

- To remove dust on the lens and viewfinder glass, use a blower, followed by the application of a lens cleaning brush. Smudges such as finger prints should be carefully wiped with a clean, soft cloth moistened with a few drops of a lens cleaning solution available on the market. Wipe the lens surface gently out from the center toward the edges in a spiral.
- Never attempt to touch the reflex mirror and focusing screen, lens, etc., with the fingers; they can be scratched very easily.
- Do not touch or handle the shutter curtains with the fingers.
- Once immersed into water, the camera will be rendered inoperable. In such a case, contact your nearest Pentax service center.

- Periodical performance checks at least once or twice a year are recommended to maintain your camera in good working condition. If you have not used your camera over a long period of time, or when important pictures are planned on an assignment, a pre-check of the operating parts and/or trial shooting is suggested.
- Non-dedicated lenses or accessories used in conjunction with the Pentax cameras may cause malfunctions and/or damage to the camera components. Always use the Pentax exclusive lenses and accessories, the quality of which is totally guaranteed by us.
- It is a good practice to immediately note the lens and camera body number against possible loss.

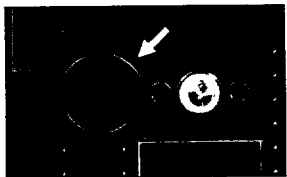

#### **Notes on the LCD (Liquid Crystal Display)**

- Under high temperature conditions, approximately 60°C or above, the LCD window may turn black. Do not be concerned, it will return to normal once the temperature stabilizes.
- Under low temperature conditions, the display response time may slow down considerably. These phenomena do not indicate a breakdown of the LCD's; it is due to the inherent characteristic of the LCD's.

#### **Notes on Reserve Battery**

- A reserve battery, CR1220 lithium battery will be placed within the bottom of the camera body at the time of delivery. It supplies the required power to maintain memory for mode settings and exposure counter information, etc. during the period the grip has been removed from the camera body, or when the batteries in the grip have been depleted. The life of the lithium battery is 5 years. In case the mode setting and the exposure counter do not normally work, for instance, due to the removal/attaching of the grip, take the camera to an authorized Pentax service facility for replacement of the lithium battery (chargeable).

## SPECIFICATIONS

**Type** 6×4.5 format SLR camera with Multi-mode automatic exposure controls. Built-in motor drive.

**Exposure Modes** Programmed AE, Aperture-priority AE, Shutter-priority AE, Metered manual, TTL auto flash, Programmed auto flash and Leaf-shutter lens modes.

**Exposure Control Mode Selection** Via Mode setting buttons and Aperture ring of 645 lenses.

**Film** 120 film (15 exposures), 220 film (30 exposures) and 70mm roll film (about 90 exposures)

**Picture Size** 56 x 41.5 mm

**Lens Mount** Pentax 645 A mount (with electronical contacts)

**Shutter** Electronically-controlled vertical-run cloth focal-plane shutter, from 15 to 1/1000 sec., 1/60 sec., B. Electro-magnetic shutter release.

**Exposure Information in Viewfinder** LED indication for Lens aperture, Shutter speeds and Exposure factor warning, Out-of-meter coupling and Shutter/aperture coupling range warning, Flash-ready signal, Flash exposure confirmation signal, 60 (1/60 sec.), B (bulb), Leaf-shutter lens [LS, F--].

**External Indication** Liquid Crystal Displays (LCD) indicate Programmed AE [Auto, P], Aperture-priority AE [Auto, f/stop], Shutter-priority AE [Auto, shutter speed], Aperture-priority AE (lens aperture set manually) [Auto, F--]. Metered

manual [M, shutter speed], 60 (1/60 sec.), B (bulb), Leaf-shutter lens [LS, F--], Exposure factor, ISO film speed, Exposure count, and Flash-ready signal.

**Flash Synchronization** Via hotshoe (X-synch. contact, dedicated flash contacts) and X-synch. socket. X-synch. speed at 1/60 sec. Slow shutter speed synchronization possible in Metered manual mode.

**Viewfinder** Keplerian telescopic viewfinder with Split-image/microprism Clear-Bright-Matte screen (Interchangeable focusing screens available.); Viewing area 92% vertical and 93% horizontal, 0.75X magnification with 75mm lens at infinity and -1 diopter. Diopter adjustment possible from -5 to +2 diopters.

**Mirror** Instant return mirror

**Film Loading** 120 and 220 films semi-automatically loaded with a start mark, 70mm film automatically.

**Film Winding** Automatic film winding by motor with Single/Consecutive shooting modes (Single: 1 frame/sec., Consecutive: approx. 1.5 frames/sec.). Film automatically stops at end of film trailer.

**Exposure Counter** LCD indication, additive type, automatic resetting. Automatically sets shutter speed at 1/1000 sec. up to first frame. Exposure count does not advance in multiple-exposure mode.

**Multiple Exposure** Via Multi-exposure ring. cancellation possible.

**Exposure Metering** Open-aperture, center-weighted TTL metering by GPD cells. Off-the-film metering for dedicated TTL automatic electronic flashes.

**Exposure Range** From EV 3 (f/2.8 at 1 sec.) to EV 19 (f22 at 1/1000 sec.) with 75mm f/2.8 lens with ISO 100 film.

**Film Speed Usable** ISO 6 ~ 6400.

**Exposure Compensation** Via Exposure factor button. Setting at +3, +2, +1, 0, -1, -2 and -3.

**Depth-Of-Field Preview** Via Preview lever when aperture set manually.

**Power Source and Battery Life** Six 1.5V "AA" batteries (manganese, alkaline or Ni-Cd) for exposure control/display circuits and motor drive. Automatically turns power off 30 seconds after removing finger from release button.

	Power Source		
	Manganese Battery:	Alkaline Battery:	Ni-Cd Battery:
120 Film	Approx. 100 rolls	Approx. 250 rolls	Approx. 100 rolls
220 Film	Approx. 70 rolls	Approx. 170 rolls	Approx. 70 rolls
70mm Film	Approx. 20 rolls	Approx. 50 rolls	Approx. 20 rolls

**Memory Power Source** One built-in lithium battery for exposure data memory circuits. Minimum battery life 5 years. (Replaced at Pentax service center).

**Size and Weight** 147 (W) x 109 (H) x 117mm (D), 1.320g, 5.7" (W) x 4.3" (H) x 4.6" (D), 46.2 oz. (with grip and film holder without lens)

**Accessories** Large eyecup 645, Body mount cap 645, Rear body cap 645 and Strap B.

**SPECIFICATIONS ARE SUBJECT TO CHANGE AT ANY TIME WITHOUT NOTIFICATION OR ANY OBLIGATION ON THE PART OF THE MANUFACTURER.**

## **WARRANTY POLICY**

All Pentax cameras purchased through authorized bona fide photographic distribution channels are guaranteed against defects of material or workmanship for a period of twelve months from date of purchase. Service will be rendered and defective parts will be replaced without cost to you within that period, provided your camera has not been abused, altered, or operated contrary to instruction. Because the tolerances, quality, and design compatibility of lenses other than Pentax lenses are beyond our control, damage caused by use of such lenses will not be covered by this warranty policy. The manufacturer or its authorized representatives shall not be liable for any repair of alterations except those made with its written consent and shall not be liable for damages from delay or loss of use or from other indirect or consequential damages of any kind, whether caused by defective material or workmanship or otherwise; and it is expressly agreed that the liability of the manufacturer or its representatives under all guarantees or warranties, whether expressed or implied, is strictly limited to the replacement of parts as hereinbefore provided.

### **PROCEDURE DURING 12-MONTH WARRANTY PERIOD**

Any Pentax camera which proves defective during the 12-month warranty period should be returned to the dealer from whom you purchased your camera or to the manufacturer. If there is no representative of the manufacturer in your country, send your camera to the manufacturer, with postage prepaid. In this case, it will take a considerable length of time before your camera can be returned to you owing to the complicated customs procedures required in Japan in importing and re-exporting photographic equipment. If your camera is covered by warranty, repairs will be made and parts replaced free of charge, and your camera will be returned to you upon completion of servicing. If your camera is not covered by warranty, regular charges of the manufacturer or of its representatives will apply. Shipping charges are to be borne by the owner. If your Pentax camera was purchased outside of the country where you wish to have serviced during the warranty period, regular handling and servicing fees may be charged by the manufacturer's representative in that country.



Notwithstanding this, your Pentax camera returned to the manufacturer will be serviced free of charge according to this procedure and warranty policy. In any case, however, shipping charges and customs clearance fees are to be borne by the owner. To prove the date of your purchase when required, please keep the receipts or bills covering the purchase of your camera for at least a year. Before sending your camera for servicing, please make sure that you are sending it to the manufacturer's authorized representatives or their approved repair shops, unless you are sending it directly to the manufacturer. Always obtain a quotation of the service charge, and only after you accept the quoted service charge, instruct the service station to proceed with the servicing.

**This warranty policy does not apply to Pentax cameras purchased in the U.S.A., U.K., or Canada. The local warranty policies available from Pentax distributors in those countries supersede this warranty policy.**

**FOR YOUR MEMO.**



**Asahi Optical Co., Ltd.** 11-1, Nagata-cho 1-chome, Chiyoda-ku, Tokyo 100, JAPAN  
**Pentax Europe n.v.** Weveldlaan 3-5, 1930 Zaventem, BELGIUM  
**Pentax Handelsgesellschaft mbH.** Julius-Vosseler-Strasse, 104, 2000 Hamburg 54, GERMANY  
**Pentax U.K. Limited.** Pentax House, South Hill Avenue, South Harrow, Middlesex HA2 0LT, U.K.  
**Pentax France Z.I.** Argenteuil, 12, rue Ambroise Croizat, 95106 Argenteuil, FRANCE  
**Pentax Benelux** (for Netherlands) Spinveld 25, 4815 HR Breda, NETHERLANDS  
(for Belgium & Luxemburg) Weveldlaan 3-5, 1930 Zaventem, BELGIUM  
**Pentax (Schweiz) AG** Industriestrasse 2, 8305 Dietlikon, SWITZERLAND  
**Pentax Scandinavia AB** Falhagsleden 57, 75127 Uppsala, SWEDEN  
**Pentax Corporation** 35 Inverness Drive East, Englewood, Colorado 80112, U.S.A.  
**Pentax Canada Inc.** 3131 Universal Drive, Mississauga, Ontario L4X 2E5, CANADA  
**Asahi Optical Brasileira Ind. e Com. Ltda.** Rua Estados Unidos, 1053, São Paulo, BRAZIL